

# E2C/E2C-H

## Separate Amplifier Sensor with Sensitivity Adjustment











- Compact design with smaller Sensor Head.
- Heat-resistance model available for application between -10 and 200°C.



 Be sure to read *Safety Precautions* on page 15.

## Ordering Information





**Sensors** [Refer to *Dimensions* on page 18.]  
**Standard Models**

Sensor				Combination	Amplifier Units			
Appearance	Stable sensing area *	Model	Model		Power supply/ Output	Timer function	Self-diag- nostic output	
Shielded 	3.5 dia. 	0.8 (1.8) mm	E2C-CR8A 3M	→	E2C-GE4A	DC/ (NPN)	---	---
	3.8 dia. 	0.8 (1.8) mm	E2C-CR8B 3M		E2C-GF4A	DC/ (PNP)	---	---
	M5 	1 (2) mm	E2C-X1A 3M		E2C-JC4AP 2M *	DC/ (NPN)	Yes	Yes
	5.4 dia. 	1 (2) mm	E2C-C1A 3M		E2C-JC4A 2M	DC/ (NPN)	Yes	---
	M8 	1.5 (3) mm	E2C-X1R5A 3M		E2C-AM4A	DC/(NPN) (PNP)	---	---
	M12 	2 (5) mm	E2C-X2A 3M		E2C-AK4A	AC	---	---
	M18 	5 (10) mm	E2C-X5A 3M					
Unshielded 	40 dia. 	10 (18) mm 20 (50) mm	E2C-C20MA 3M					

\*1. Values in parentheses are for the maximum sensing distances at 23°C.

\* Self-diagnostic output, timer, and DIN Track mounting.

### Heat-resistant Model

Sensor				Combination	Amplifier Unit
Appearance	Stable sensing area	Model	Model		
Shielded 	M8 	1.5 mm	E2C-X1R5AH 3M	→	E2C-JC4CH 2M
	M12 	2 mm	E2C-X2AH 3M	→	E2C-JC4DH 2M
	M18 	5 mm	E2C-X5AH 3M	→	E2C-JC4EH 2M

Note: Characteristics will change if the cable length changes. Do not cut or extend the cable.

## Accessories (Order Separately)

**Mounting Brackets** A Mounting Bracket is not provided with the Sensor. Order a Mounting Bracket separately if required.

[Refer to Dimension on page 21.]

Name	Model	Applicable Sensors	Remarks
Mounting Brackets	Y92E-F3R5	E2C-CR8A, for 3.5 dia.	---
	Y92E-F5R4	E2C-C1A, for 5.4 dia.	

**Connection Sockets** A Socket is not provided with the Amplifier Unit. Order a Socket separately if required.

[Refer to Dimension on page 21.]

Name	Model	Applicable Amplifier Unit	Remarks
Front Connection Sockets	PYF08A	E2C-GE4A E2C-GF4A	Hold-down Clips (Order Separately) PYC-A1 Sold as a set.
	P2CF-08	E2C-AM4A	
	P2CF-11	E2C-AK4A	
Back Connection Sockets	P3G-08	E2C-AM4A	---
	P3GA-11	E2C-AK4A	
	PY08	E2C-GE4A E2C-GF4A	

**Adapters** An Adapter is not provided with the Amplifier Unit. Order an Adapter separately if required.

[Refer to Dimension on page 21.]

Name	Model	Applicable Amplifier Unit	Remarks
Embedded Adapters	Y92F-30	E2C-AM4A/-AK4A	---
	Y92F-70		
	Y92F-71		

For details on [Mounting Brackets](#), [Protective Covers](#), and [Sputter Protective Covers](#), refer to *Accessories* on Y92□.

## Ratings and Specifications

### Standard Models

#### Sensors

Model		E2C-CR8A/ -CR8B	E2C-X1A/ -C1A	E2C-X1R5A	E2C-X2A	E2C-X5A	E2C-X10A	E2C-C20MA
Item								
Sensing distance (at 23°C)		1.8 mm	2 mm	3 mm	5 mm	10 mm	18 mm	50 mm
Stable sensing area	Ambient temperature	0 to 0.8 mm	0 to 1 mm	0 to 1.5 mm	0 to 2 mm	0 to 5 mm	0 to 10 mm	0 to 20 mm
	At 0 to 40°C	0 to 1.2 mm	0 to 1.5 mm	0 to 2 mm	0 to 2.5 mm	0 to 7 mm	0 to 15 mm	0 to 28 mm
Differential travel		Refer to <i>Ratings and Specifications</i> on page 4 for Amplifier Unit specifications.						
Detectable object		Ferrous metal (The sensing distance decreases with non-ferrous metal. Refer to <i>Engineering Data</i> on page 7.)						
Standard sensing object		Iron, 5 × 5 × 1 mm		Iron, 8 × 8 × 1 mm	Iron, 12 × 12 × 1 mm	Iron, 18 × 18 × 1 mm	Iron, 30 × 30 × 1 mm	Iron, 50 × 50 × 1 mm
Response frequency *1		1 kHz		800 Hz		350 Hz	100 Hz	50 Hz
Ambient temperature range		Operating/Storage: -25 to 70°C (with no icing or condensation)						
Ambient humidity range		Operating/Storage: 35% to 95% (with no condensation)						
Temperature influence		15% max. of sensing distance at 23°C in the temperature range of -25 to 70°C						
Vibration resistance		Destruction: 10 to 55 Hz, 1.5-mm double amplitude for 2 hours each in X and Y directions						
Shock resistance		Destruction: 500 m/s <sup>2</sup> 3 times each in X and Y directions						
Degree of protection		IEC 60529 IP67, in-house standards: oil-resistant						
Connection method *2		Pre-wired Models High-frequency coaxial cable (Standard cable length: 3 m)						
Weight (packed state)		Approx. 40 g	Approx. 45 g	Approx. 50 g	Approx. 60 g	Approx. 140 g	Approx. 270 g	Approx. 300 g
Materials	Case	Stainless steel	Brass					
	Sensing surface	ABS resin						
	Cable	Polyethylene						
	Clamping nut	---	Brass, nickel-plated (except E2C-C1A)					
	Toothed washer	---	Brass, zinc-plated (except E2C-C1A)					
Accessories		---						

\*1. The minimum value when using the solid-state control output on the Amplifier Unit.

Measurement conditions are as follows: standard sensing object, a distance of twice the standard sensing object, and a set distance of half the sensing distance.

\*2. Refer to 6 for cable lengths when combining Amplifier Units and Sensors.

The characteristic impedance of the high-frequency coaxial cable is 50 Ω.

## Amplifier Units

Model		E2C-GE4A	E2C-GF4A	E2C-JC4A E2C-JC4AP	E2C-AM4A	E2C-AK4A
Power supply voltage (operating voltage range)		12 to 24 VDC (10 to 30 VDC), ripple (p-p): 10% max. *1				100 to 240 VAC (90 to 264 VAC) 50/60 Hz
Current consumption		25 mA max.		45 mA max.	50 mA max.	55 mA max.
Sensing distance adjustment range *2		20% min. of rated sensing distance with 4-turn potentiometer		20% to 100% of rated sensing distance with 4-turn potentiometer		
Differential travel adjustment range		Differential travel fixed (10% max. of sensing distance)			1% to 5% of rated sensing distance	
Response time	Solid-state	(Refer to the response frequency of the Proximity Sensor.)				
	Relay	---				20 ms max.
Control outputs	Solid-state	NPN Load resistance: 4.7 k $\Omega$ , 100 mA max. (30 VDC max.) (Residual voltage: 1.5 V max.)	PNP Load resistance: 4.7 k $\Omega$ , 100 mA max. (30 VDC max.) (Residual voltage: 1.5 V max.)	NPN Open-collector output 100 mA max. (30 VDC max.) (Residual voltage: 0.7 V max.) (E2C-JC4AP: 1 V max.)	NPN/PNP output Open-collector output 200 mA max. (30 VDC max.) (Residual voltage: 1.5 V max.)	Transistor/photocoupler 50 mA max. (40 VDC max.) (Residual voltage: 2 V max.)
	Relay	---				Relay output, SPDT 2 A at 250 VAC, $\cos\phi = 1$ (resistive load) *3
Indicators		Detection indicator (red) (OPERATION)		Detection indicator (red) (OPERATION) Stability indicator (green) (STABILITY)	Detection indicator (red) (OPERATION) Stability indicator (green) (STABILITY)	
Operation mode		Changed with NO/NC switch.				
Self-diagnostic output		---		(E2C-JC4AP only) Output transistor turns ON when Sensor open circuit or unstable sensing is detected; solid-state NPN open-collector 50 mA max. (30 VDC max.) (Residual voltage: 1 V max.)	---	
Timer function		---		OFF-delay: 40 $\pm$ 10 ms	---	
Cable length compensation between Sensor and Amplifier Unit		---		(E2C-JC4AP only) 3 m/5 m, terminals Short-plate switching Shorted: 1 to 3 m Open: 3 to 5 m	Mode switched with 4-position switch.	
Ambient temperature range		Operating/storage: -10 to 55°C (with no icing or condensation)				
Ambient humidity range		Operating/Storage: 35% to 85% (E2C-JC4AP: 35% to 95%) (with no condensation)				
Temperature influence		10% max. of sensing distance at 23°C in the temperature range of -10 to 55°C				
Voltage influence		DC Models: $\pm$ 1% max. of sensing distance at rated voltage in the rated voltage $\pm$ 20% range AC Models: $\pm$ 1% max. of sensing distance at rated voltage in the rated voltage $\pm$ 10% range				
Insulation resistance		50 M $\Omega$ min. (at 500 VDC) between current-carrying parts and case				
Dielectric strength		DC Models: 1,000 VAC, 50/60 Hz for 1 min between current-carrying parts and case AC Models: 1,500 VAC, 50/60 Hz for 1 min between current-carrying parts and case				
Vibration resistance		Destruction: 10 to 25 Hz, 2-mm double amplitude for 2 hours each in X, Y, and Z directions		Destruction: 10 to 55 Hz, 1.5-mm double amplitude for 2 hours each in X, Y, and Z directions	Destruction: 10 to 25 Hz, 2-mm double amplitude for 2 hours each in X, Y, and Z directions	

\*1. A full-wave rectification power supply of 24 VDC  $\pm$ 10% (average value) can be used (except for the E2C-GE4□).

\*2. The sensing distance range required to maintain performed is given for using the Amplifier Unit in combination with the Sensor.

\*3. Internal relay: G2R-14 DC 12V

Item	Model	E2C-GE4A	E2C-GF4A	E2C-JC4A E2C-JC4AP	E2C-AM4A	E2C-AK4A
Shock resistance	Destruction: 100 m/s <sup>2</sup> 3 times each in X, Y, and Z directions					
Life expectancy	---					Mechanical: 10,000,000 operations min. Electrical: 100,000 operations min.
Connection method	Terminal block			Pre-wired Models (Standard cable length: 2 m)	Terminal block	
Weight (packed state) *4	Approx. 20 g			E2C-JC4A: Approx. 50 g E2C-JC4AP: Approx. 80 g	Approx. 140 g	Approx. 250 g
Accessories	Instruction manual			Caution labels, Mounting Bracket (E2C-JC4A: M3 × 15 Phillips mounting screw), instruction manual	Instruction manual	

\*4. The weight of the Connection Socket is not included.

## Heat-resistant Models

### Sensors

Item	Model	E2C-X1R5AH	E2C-X2AH	E2C-X5AH
Detectable object	Ferrous metal (The sensing distance decreases with non-ferrous metal, refer to <i>Engineering Data</i> on page 7.)			
Standard sensing object	Iron, 8 × 8 × 1 mm	Iron, 12 × 12 × 1 mm	Iron, 18 × 18 × 1 mm	
Stable sensing area	0 to 1.5 mm	0 to 2 mm	0 to 5 mm	
Differential travel	0.04 mm max.		0.1 mm max.	
Response frequency *1	300 Hz			
Ambient temperature range	Operating/Storage: -10 to 200°C (with no icing or condensation)			
Ambient humidity range	Operating/Storage: 35% to 95% (with no condensation)			
Temperature influence	±0.2%/°C			
Vibration resistance	Destruction: 10 to 55 Hz, 1.5-mm double amplitude for 2 hours each in X, Y, and Z directions			
Shock resistance	Destruction: 500 m/s <sup>2</sup> 3 times each in X, Y, and Z directions			
Degree of protection	IEC 60529 IP60 *2			
Connection method	Pre-wired Models (Cable length: 3 m) Heat-resistant, high-frequency coaxial cable			
Weight (packed state)	Approx. 50 g	Approx. 60 g	Approx. 140 g	
Materials	Case	Brass		
	Sensing surface	PEEK (polyether ether ketone)		
	Cable	Fluorine resin		
	Clamping nut	Brass, nickel-plated		
	Toothed washer	Iron, zinc-plated		

Note: Ratings and characteristic are given for 50% of the stable sensing area.  
\*1. Measurement conditions are as follows: standard sensing object, a distance of twice the standard sensing object, and a set distance of half the sensing distance.

\*2. Do not operate the Sensor in areas exposed to water vapor because the enclosure is not waterproof.

### Amplifier Units

Item	Model	E2C-JC4CH	E2C-JC4DH	E2C-JC4EH
Power supply voltage *1 (operating voltage range)	12 to 24 VDC (10 to 30 VDC), ripple (p-p): 10% max.			
Current consumption	45 mA max.			
Sensing distance adjustment range *2	20% to 100% of rated sensing distance 4-turn potentiometer			
Control outputs	Load current	NPN open collector, 100 mA max. (30 VDC max.)		
	Residual voltage	0.8 V max.		
Indicators	Detection indicator (red)			
Operation mode	Changed with NO/NC switch.			
Cable length compensation	Switched between 3 and 5 m.			
Ambient temperature range	Operating/storage: -10 to 55°C (with no icing or condensation)			
Ambient humidity range	Operating/storage: 35% to 85% (with no condensation)			
Temperature influence	±0.08%/°C			
Voltage influence	±2% max. of sensing distance at rated voltage in the rated voltage ±20% range			
Insulation resistance	50 MΩ min. (at 500 VDC) between current-carrying parts and case			
Dielectric strength	1,000 VAC, 50/60 Hz for 1 min between current-carrying parts and case			
Vibration resistance	Destruction: 10 to 55 Hz, 1.5-mm double amplitude for 2 hours each in X, Y, and Z directions			
Shock resistance	Destruction: 100 m/s <sup>2</sup> 3 times each in X, Y, and Z directions			
Degree of protection	IEC 60529 IP20			
Connection method	Pre-wired Models (Cable length: 2 m)			
Weight (packed state)	Approx. 80 g			
Accessories	Caution labels, Mounting Bracket, instruction manual			

\*1. A full-wave rectification power supply of 24 VDC ±10% (average value) can be used.

\*2. The sensing distance range required to maintain performed is given for using the Amplifier Unit in combination with the Sensor.

## Cable Lengths for Sensor-Amplifier Unit Combinations

### Standard Models

Sensor Amplifier Units	E2C-CR8A	E2C-CR8B	E2C-X1A	E2C-C1A	E2C-X1R5A	E2C-X2A	E2C-X5A	E2C-X10A	E2C-C20MA
E2C-GE4A	Restricted to 3 m.					---	---	---	---
E2C-GF4A	Restricted to 3 m.					---	---	---	---
E2C-JC4AP	1 to 3 m: Short cable length terminals *					---		---	---
E2C-JC4A	3 to 5 m: Open cable length terminals *					---		---	---
E2C-AM4A	0 to 5 m					0 to 10 m			
E2C-AK4A	Set cable length switch to desired position. *					Set cable length switch to desired position. *			

Note: The standard cable length is 3 m. Models with 5-m or 10-m are manufactured upon order.  
\* Refer to page 14 for the operation of cable length switching.

### Heat-resistant Models

Sensor Amplifier Units	E2C-X1R5AH	E2C-X2AH	E2C-X5AH
E2C-JC4CH	Set 3 m/5 m cable length switch to desired position.		
E2C-JC4DH			
E2C-JC4EH			

Note: The standard cable length is 3 m. Models with 5-m are manufactured upon order.

## Self-diagnostic Function

The self-diagnostic output transistor will turn ON in the following cases. (The output will turn ON for any of these conditions individually.)

(1) Sensor open circuit: Transistor will turn ON the instance there is an open circuit for the Sensor (including the cable).

### Sensor Open Circuit

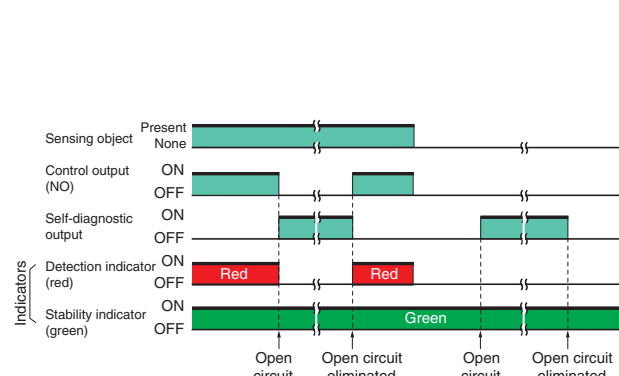

### Sensor Connected

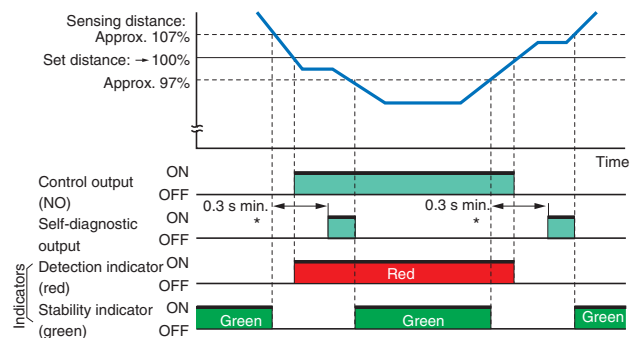

Note: When the E2C-X2A Sensor is used, 93% is 96% and 107% is 104%.  
\* The self-diagnostic output may turn ON if the sensing objects moves a low speed. In actual application, include an ON-delay timer circuit or other suitable measure.

(2) Detection: The output will turn ON if a sensing object is within 93% to 100% of the sensing distance continuously for 0.3 s or longer (e.g., for sensing object position offset).

(3) No detection: The output will turn ON if a sensing object is within 100% to 107% of the sensing distance continuously for 0.3 s or longer (e.g., when background is influencing detection).

## Indicators

- The detection indicator lights when a sensing object approaches the sensing distance to indicate that a sensing object has been detected.
- The stability indicator lights when the sensing object approaches within 93% of the sensing distance or moves away from 107% of the sensing distance to indicate a stable sensing or non-sensing condition.

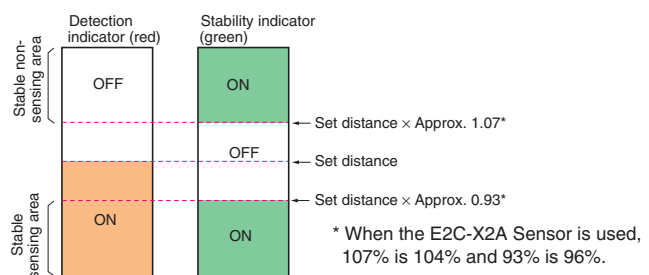

\* When the E2C-X2A Sensor is used, 107% is 104% and 93% is 96%.

## Engineering Data (Reference Value)

### Sensing Area

#### E2C-CR8

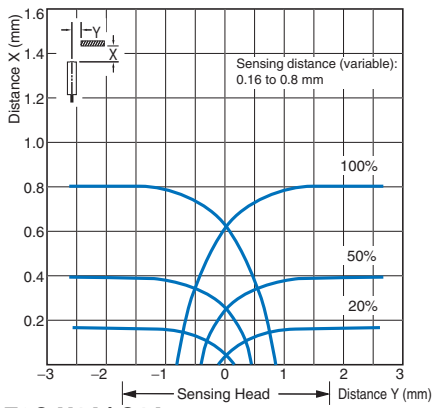

#### E2C-X1A/C1A

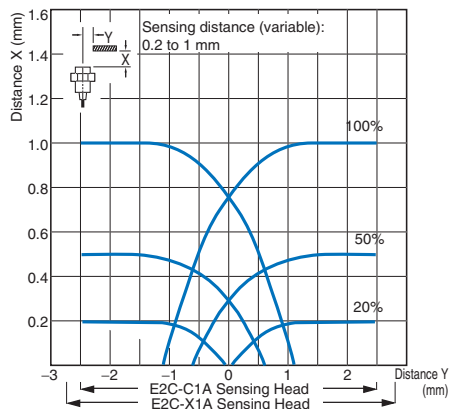

#### E2C-X1R5A

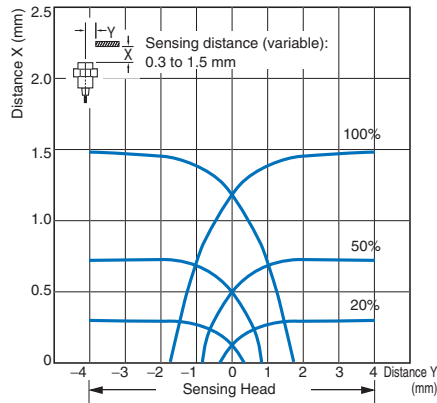

#### E2C-X2A

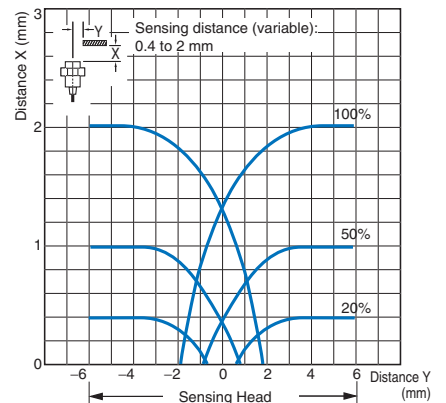

#### E2C-X5A

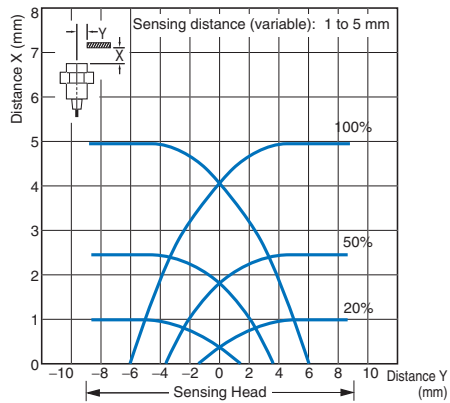

#### E2C-X10A

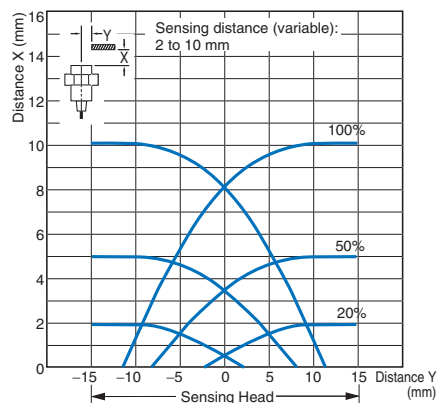

#### E2C-C20MA

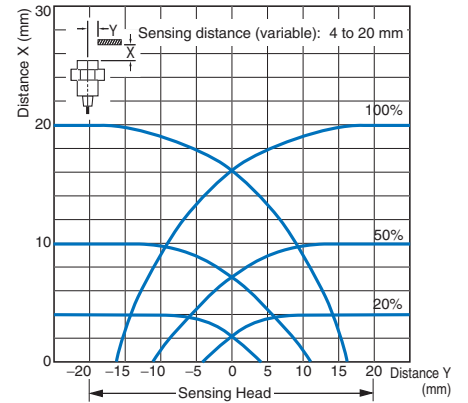

#### E2C-X1R5AH + E2C-JC4CH

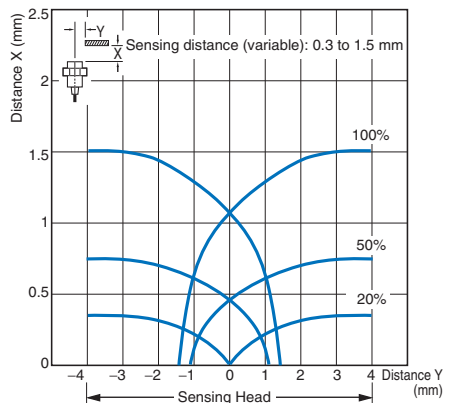

#### E2C-X2AH + E2C-JC4DH

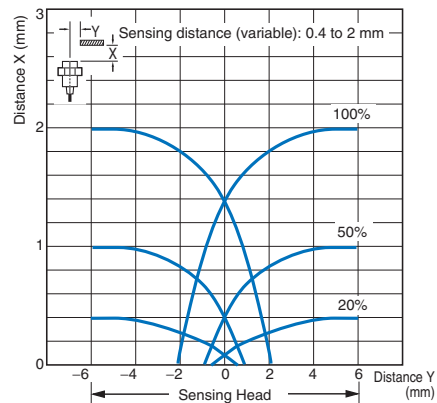

#### E2C-X5AH + E2C-JC4EH

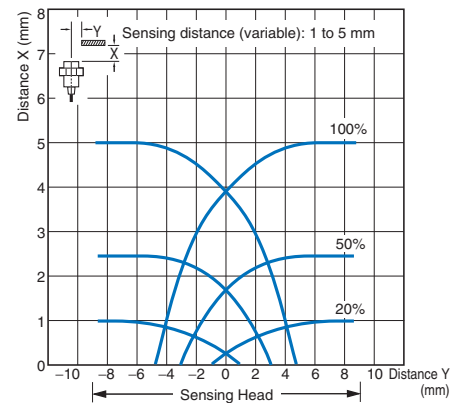

## Influence of Sensing Object Size and Material

### E2C-CR8

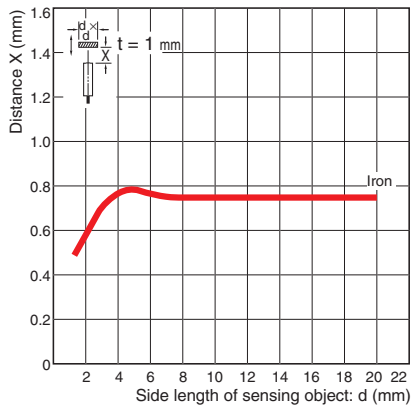

### E2C-X1A/-C1A

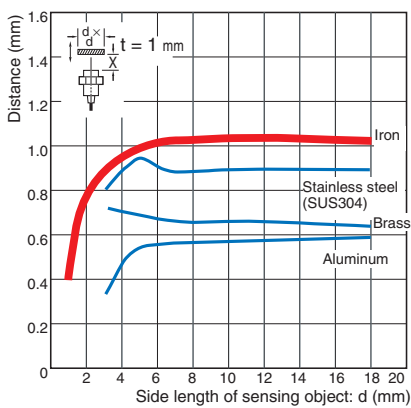

### E2C-X1R5A

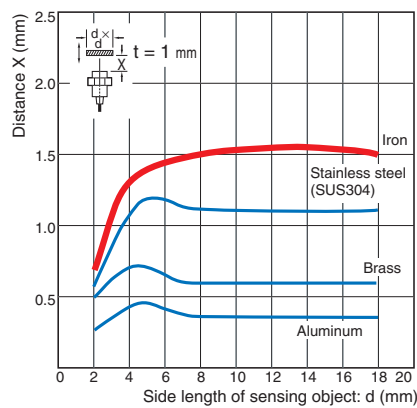

### E2C-X2A

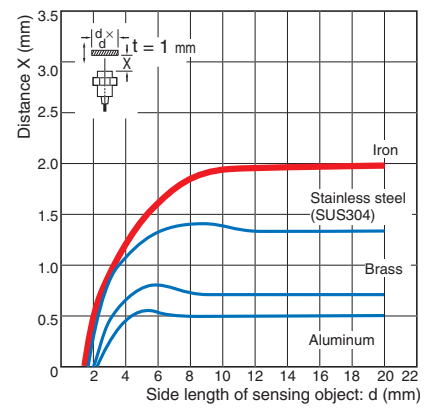

### E2C-X5A

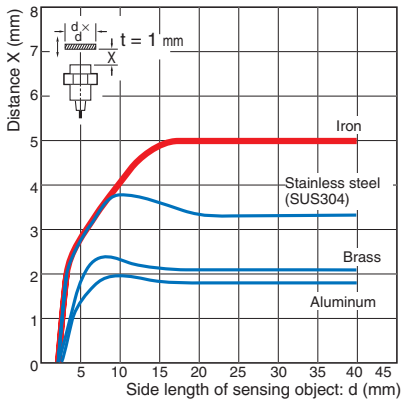

### E2C-X10A

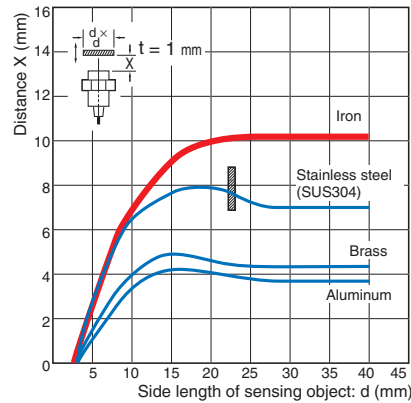

### E2C-C20MA

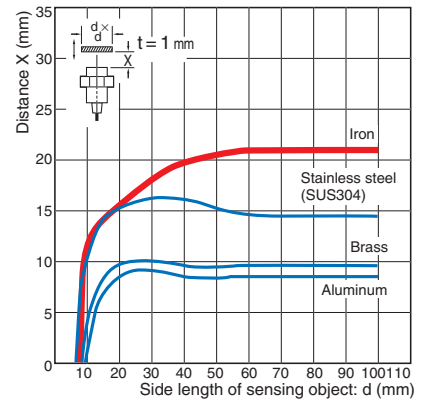

### E2C-X1R5AH + E2C-JC4CH

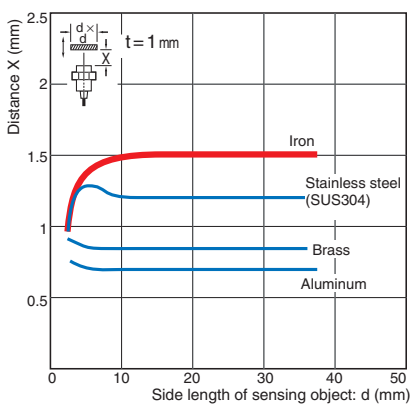

### E2C-X2AH + E2C-JC4DH

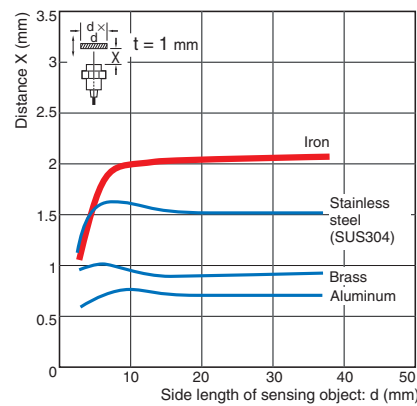

### E2C-X5AH + E2C-JC4EH

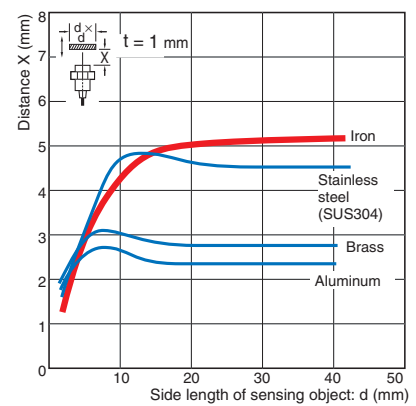

I/O Circuit Diagrams

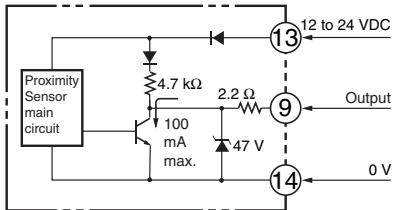
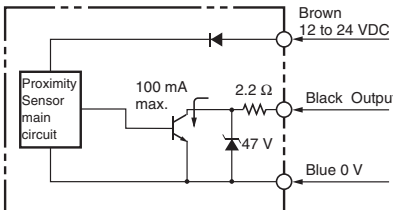
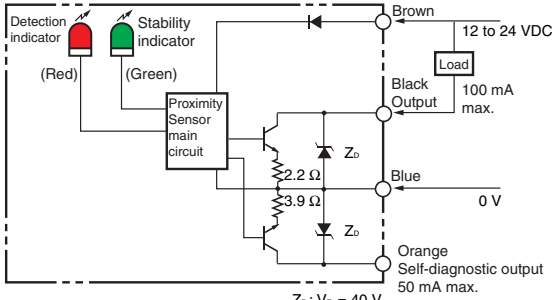
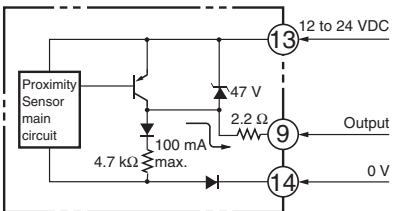
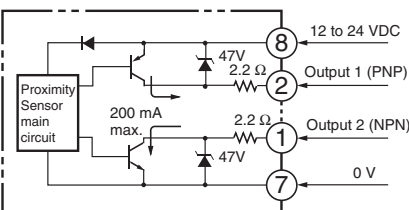
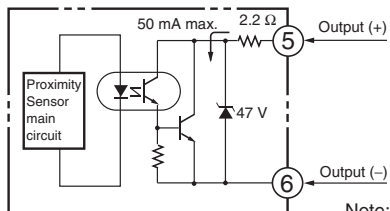
Output configuration	E2C-GE4A *	E2C-JC4A, E2C-JC4CH, E2C-JC4DH, E2C-JC4EH
NPN output	 <p>* A voltage output can be used if the NO/NC switch on the E2C-GE4A is set to NC, but an approximately 60-ms pulse will be generated when the power supply is turned ON. An initial reset will thus be required. If the E2C-GF4A (model for PNP output) is used, the initial pulse will not occur.</p>	
NPN output Self-diagnosis Function	<p style="text-align: center;"><b>E2C-JC4AP</b></p>  <p style="text-align: center;">Zs: Vz = 40 V</p>	
PNP Output	<p style="text-align: center;"><b>E2C-GF4A</b></p> 	
Both NPN and PNP outputs	<p style="text-align: center;"><b>E2C-AM4A</b></p> 	
Transistor/ photocoupler Relay output	<p style="text-align: center;"><b>E2C-AK4A</b></p>  <p>Note: Terminals 1, 2, and 3 are the relay contact output (SPDT).</p>	

## Connections between Amplifier Unit and Sensor

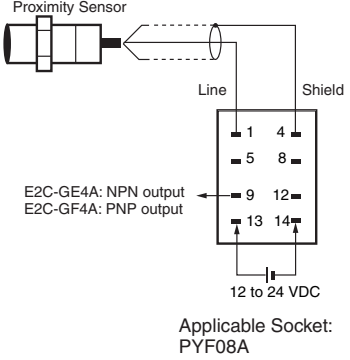
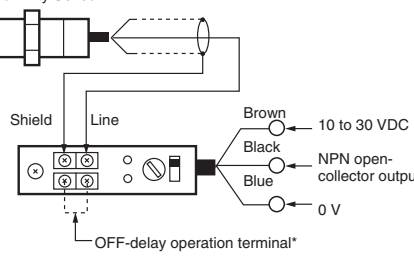
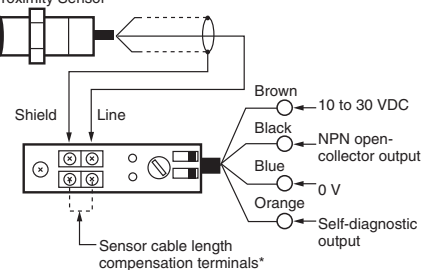
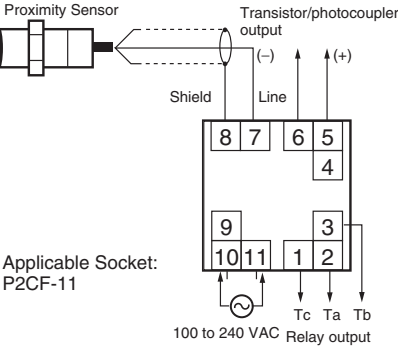
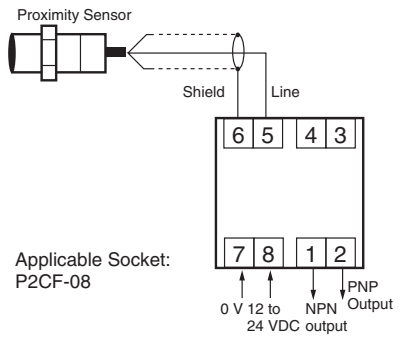
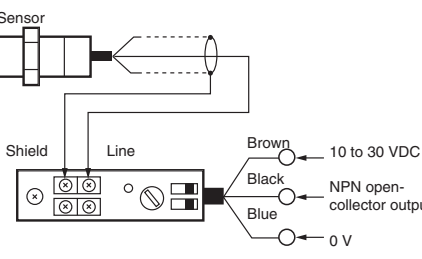
E2C-G□4A	E2C-JC4A	E2C-JC4AP
 <p>Proximity Sensor</p> <p>Line Shield</p> <p>1 4 5 8 9 12 13 14</p> <p>E2C-GE4A: NPN output E2C-GF4A: PNP output</p> <p>12 to 24 VDC</p> <p>Applicable Socket: PYF08A</p>	 <p>Proximity Sensor</p> <p>Shield Line</p> <p>6 5 4 3</p> <p>7 8 1 2</p> <p>9 10</p> <p>Brown 10 to 30 VDC Black NPN open-collector output Blue 0 V 0 V</p> <p>OFF-delay operation terminal*</p> <p>* OFF-delay timer setting If the OFF-delay operation terminals are shorted, a 40-ms OFF-delay timer will start.</p> <p>Applicable Socket: P2CF-08</p>	 <p>Proximity Sensor</p> <p>Shield Line</p> <p>6 5 4 3</p> <p>7 8 1 2</p> <p>9 10</p> <p>Brown 10 to 30 VDC Black NPN open-collector output Blue 0 V Orange Self-diagnostic output</p> <p>Sensor cable length compensation terminals*</p> <p>* Sensor Cable Length Compensation These terminals can be used to switch the cable length. Terminals shorted: 1 to 3 m Terminals open: 3 to 5 m</p>
 <p>Proximity Sensor</p> <p>Shield Line</p> <p>8 7 6 5 4 9 10 11 1 2 3 4</p> <p>Transistor/photocoupler output (-) (+)</p> <p>Applicable Socket: P2CF-11</p> <p>100 to 240 VAC Relay output</p> <p>Tc Ta Tb</p>	 <p>Proximity Sensor</p> <p>Shield Line</p> <p>6 5 4 3</p> <p>7 8 1 2</p> <p>0 V 12 to 24 VDC output</p> <p>NPN Output</p> <p>Applicable Socket: P2CF-08</p>	 <p>Sensor</p> <p>Shield Line</p> <p>6 5 4 3</p> <p>7 8 1 2</p> <p>9 10</p> <p>Brown 10 to 30 VDC Black NPN open-collector output Blue 0 V</p> <p>Note: Characteristics will change if the cable length changes. Do not cut or extend the cable.</p>

## Load Connections

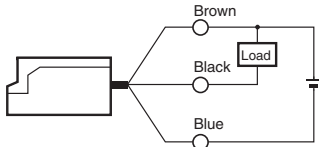
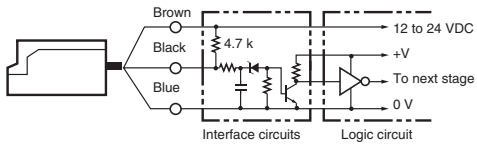
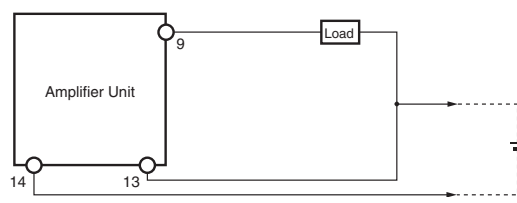
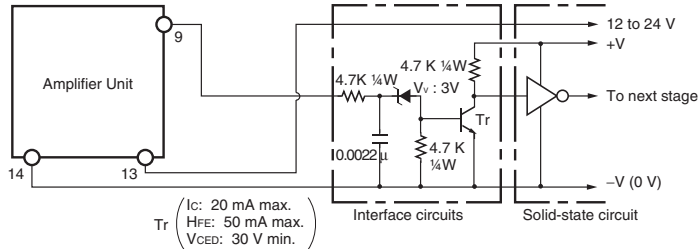
Model	E2C-JC4A, E2C-JC4□H	
Load		
DC load • Relay • Solenoid  Current-sinking load • Programmable Controller • Sensor Controller		
Voltage load (logic circuit)		
Model	E2C-GE4A	
Load		
DC load • Relay • Solenoid  Solid-state load • Programmable Controller • Sensor Controller		
Voltage load (logic circuit)	 <p> <math>I_C</math>: 20 mA max.  <math>H_{FE}</math>: 50 mA max.  <math>V_{CE0}</math>: 30 V min.         </p>	
Remarks	When connecting to a CMOS IC or TLL, provide an interface circuit as shown above and connect to the solid-state circuit in the next stage.	

Load	Model	E2C-AK4A	E2C-AM4A
<b>DC load</b> • Relay • Solenoid			<p>* Use 40 V maximum when connecting the load to a separate power supply.</p>
	<b>Solid-state load</b> • Programmable Controller • Sensor Controller	<p>* For a current-sourcing load, connect to the negative side of the transistor/photocoupler output.</p>	<p>* For a current-sourcing load, connect the PNP output.</p>
<b>Voltage loads (logic circuit)</b>			

The E2C-AK4A supports relay and transistor/photocoupler outputs, and the E2C-AM4A supports both NPN and PNP open-collector output. They can be connected to a wide variety of load types and power polarities.

## Nomenclature and Timing Charts

### Amplifier Units

#### E2C-G□4A

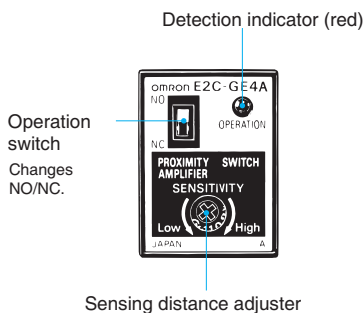

#### Timing Chart

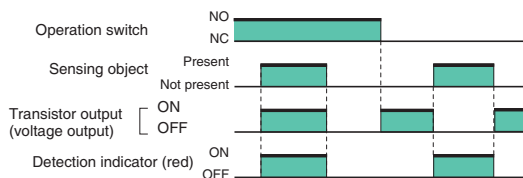

#### E2C-JC4A

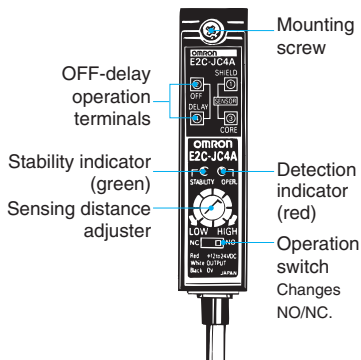

#### Timing Chart

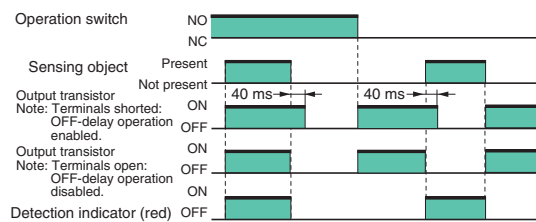

## E2C-JC4AP

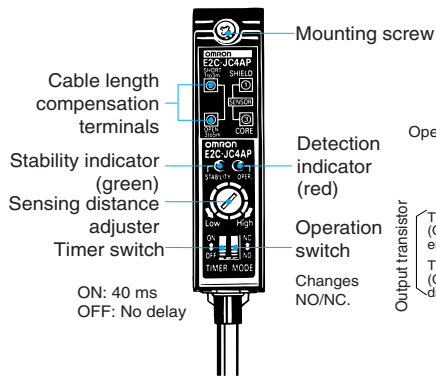

### Timing Chart

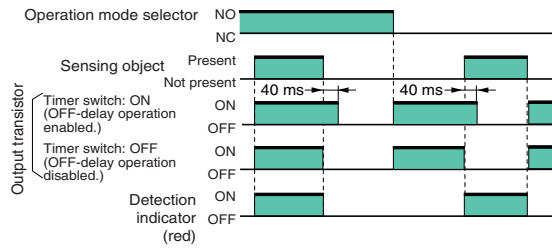

## E2C-JC4CH, E2C-JC4DH, E2C-JC4EH

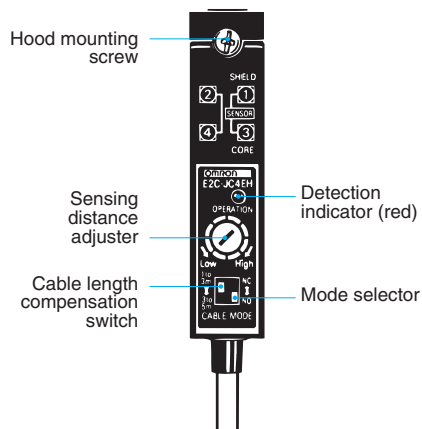

### Timing Chart

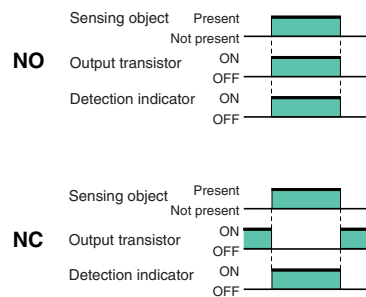

E2C-A□4A

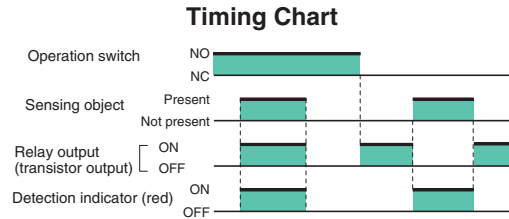
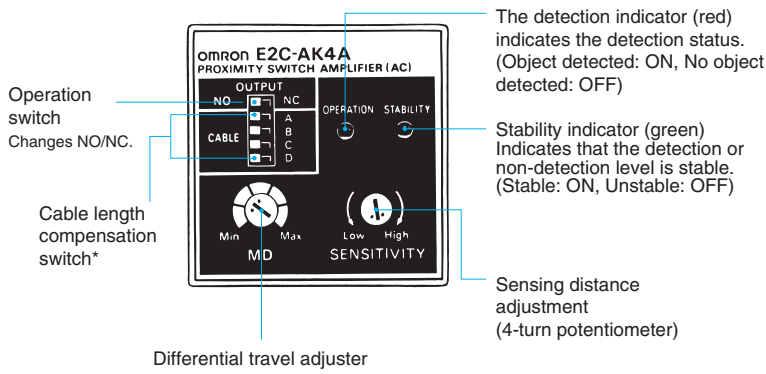

\* Cable Length Compensation Switching

Set this switch to the proper setting depending on whether the standard cable length is being used or the cable has been cut shorter.

Amplifier Unit Switch Settings

Applicable Sensors	Cable length	0 to 1 m	1 to 2 m	2 to 3 m	3 to 4 m	4 to 5 m	5 to 6 m	6 to 7 m	7 to 8 m	8 to 9 m	9 to 10 m
E2C-CR8A E2C-CR8B E2C-X1A E2C-C1A E2C-X1R5A		A B C D	A B C D	A B C D	A B C D	A B C D	—	—	—	—	—
E2C-X2A E2C-X5A E2C-X10A E2C-C20MA		A B C D	A B C D	A B C D	A B C D	A B C D	A B C D	A B C D	A B C D	A B C D	A B C D

Note: 1. Mutual Interference Prevention: When mounting Sensors with the same diameter and cable length in parallel, set the DIP switch to modes that differ by 1 m in cable length. Specifications, however, may not be sufficiently met, so always check operation before actual application. This method cannot be used for the E2C-C20MA.

2. When using the E2C-CR5B + E2C-AM4A (or AK4A), set all the pins on the Amplifier Unit DIP switch to the left.

## Safety Precautions

Refer to *Warranty and Limitations of Liability*.

### ⚠ WARNING

This product is not designed or rated for ensuring safety of persons either directly or indirectly. Do not use it for such purposes.



### Precautions for Correct Use

Do not use the Encoder under ambient conditions that exceed the ratings.

#### ● Design

#### Influence of Surrounding Metal

When mounting the Sensor within a metal panel, ensure that the clearances given in the following table are maintained. Failure to maintain these distances may cause deterioration in the performance of the Sensor.

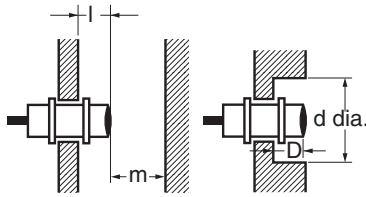

#### Influence of Surrounding Metal (Unit: mm)

Model	Distance	l	d	D	m
E2C-CR8			(3.5)		2.4
E2C-X1A			(5)		3
E2C-C1A			(5.4)		4.5
E2C-X1R5A(H)	0		(8)	0	6
E2C-X2A(H)			(12)		15
E2C-X5A(H)			(18)		30
E2C-X10A			(30)		60
E2C-C20MA	25		120	40	

Note: Values in parentheses for diameter d are the outer diameters of Shielded Models.

#### Mutual Interference

When installing Sensors face-to-face or side-by-side, ensure that the minimum distances given in the following table are maintained. Mutual interference can be prevented by using the cable length compensation switch, but doing so will also change coil characteristics. Specifications such as temperature specifications and sensing distance, may not be sufficiently met, so always check operation before actual application. This method cannot be used for the E2C-G□4A, E2C-JC4A, E2C-C20MA.

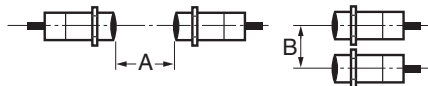

#### Mutual Interference (Unit: mm)

Model	Distance	A	B
E2C-CR8		20	15
E2C-X1A			
E2C-C1A			
E2C-X1R5A(H)		30	20
E2C-X2A(H)		50	35
E2C-X5A(H)		100	70
E2C-X10A		300	200
E2C-C20MA			

Note: The above values are for a differential travel setting of 5%.

#### Mounting

- Do not use excessive force when tightening the nuts on the E2C-X and E2C-C20MA. A washer must be used with the nut.

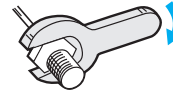

Model	Torque
E2C-X1A	0.98 N·m
E2C-X1R5A(H)	2.0 N·m
E2C-X2A(H)	5.9 N·m
E2C-X5A(H)	15 N·m
E2C-X10A	39 N·m
E2C-C20MA	15 N·m

Note: The above leeways in tighten torque assume that a toothed washer is being used.

#### ● Mounting Unthreaded Cylindrical Models

When using a set screw, tighten it to a torque of 0.2 N·m max.

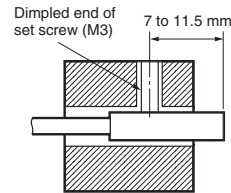

Y92E-F3R5 Mounting Bracket (for 3.5 dia.) (Order Separately)

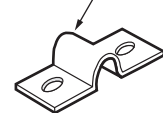

The Y92E-F5R4 (for 5.4 dia.) is also sold separately.

## ● Mounting

### Mounting the Amplifier Unit

#### E2C-JC4A

##### Lengthwise Mounting

- (1) Secure the Mounting Bracket with the enclosed M3 screws.
- (2) Loosen the M2.6 cover screw and remove the cover.
- (3) Slide the protrusion on the Amplifier Unit into the hole on the Mounting Bracket.
- (4) Using the M3 mounting screw inside the Amplifier Unit, secure the Amplifier Unit to the mounting base.
- (5) Secure the cover to the case.

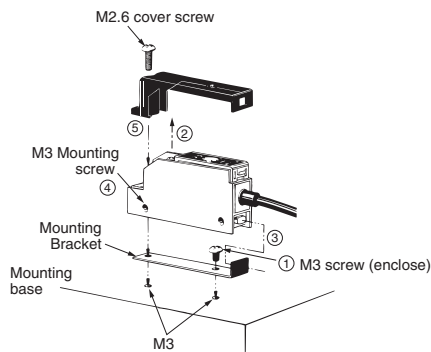

##### Mounting to the Side

- (1) Loosen the M2.6 cover screw and remove the cover. Loosen the M2.6 cover screw and remove the cover, and remove the M3 screw.
- (2) Attached the enclosed M3 screw to the cover and secure the cover to the case.
- (3) Secure the Amplifier Unit with M3 screws from the side. You must provide these screws.

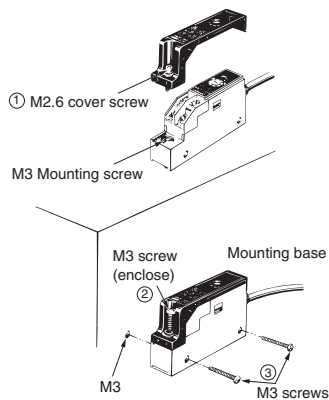

After completing adjustments, attach the enclosed caution label over the adjustment holes to prevent adjustment mistakes.



#### E2C-A□4A

##### Using P2CF-11, P2CF-08

When aligning the Amplifier Unit vertically with the Socket, consider the space required for the hooks and allow a leeway of about 20 mm above and below the Amplifier Unit.

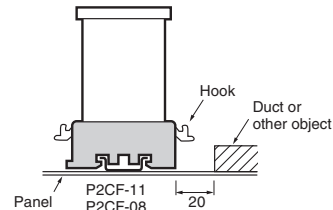

##### Mounting Embedded in a Panel

- (1) When using the Y92F-30 Embedded Mounting Adapter, insert the Amplifier Unit into a square hold in the panel, attach the Adapter from the back and press in to reduce the gap with the panel. Then secure the Adapter with the screws.

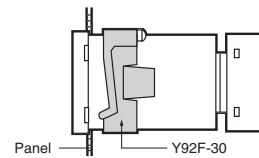

- (2) When using the Y92F-70 or Y92F-71 Embedded Mounting Adapter, just press the Amplifier into a square hole in the panel. If the panel coating is too thick and the hooks do not lock in place, spread the hooks from the back by pushing in the directions of the arrows.

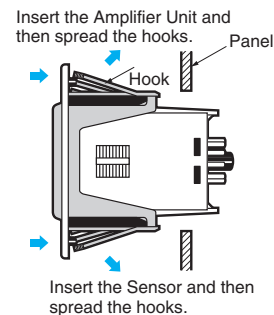

### Removing the Amplifier Unit

- When the Amplifier Unit is mounted using the Y92F-30, loosen the screws on the adapter, spread the hooks at the top and bottom, and remove the Adapter.

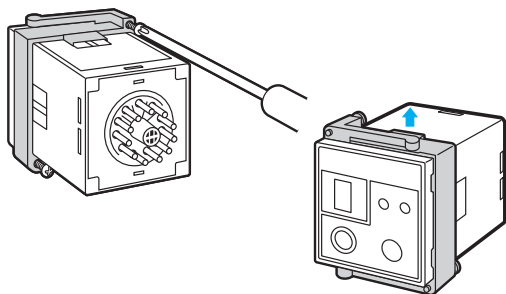

- Using Y92F-70, Y92F-71  
Press in on the hooks with your thumb and forefinger and press forward on the Amplifier Unit.

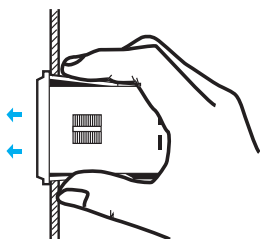

### ● Wiring

#### Self-diagnostic Output

When not using the self-diagnostic output, connect the orange wire to 0 V or cut it and wrap it with insulation tape so that it does not come into contact with other terminals.

### ● Miscellaneous

The sensor does not have a water-resistant structure. Do not use it where it would be subjected to water or water vapor.

## Dimensions

Tolerance class IT16 applies to dimensions in this data sheet unless otherwise specified.

### Main Units

#### Sensor

#### E2C-CR8A/-CR8B

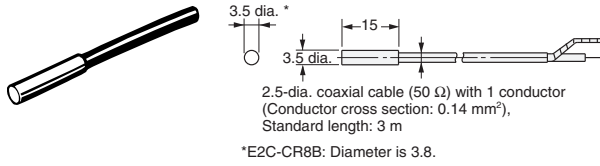

#### E2C-X1A

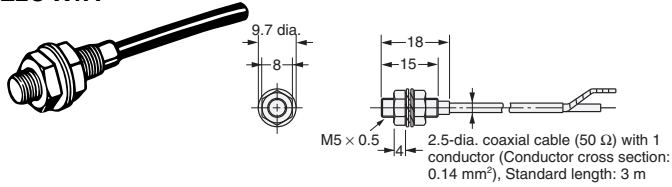

#### E2C-C1A

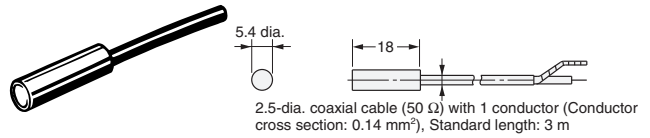

#### E2C-X1R5A

#### E2C-X1R5AH\*

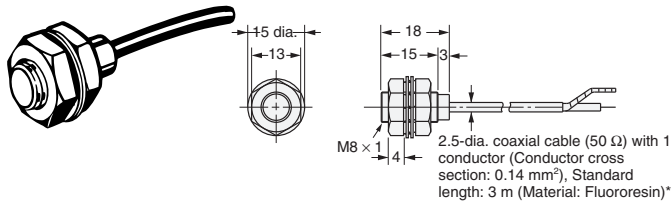

#### E2C-X2A

#### E2C-X2AH\*

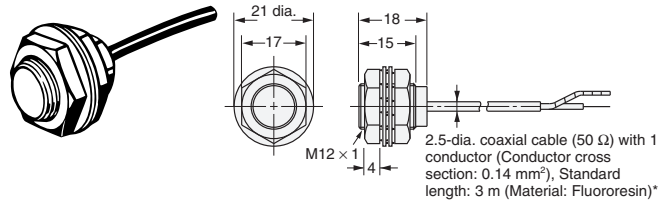

#### E2C-X5A

#### E2C-X5AH\*

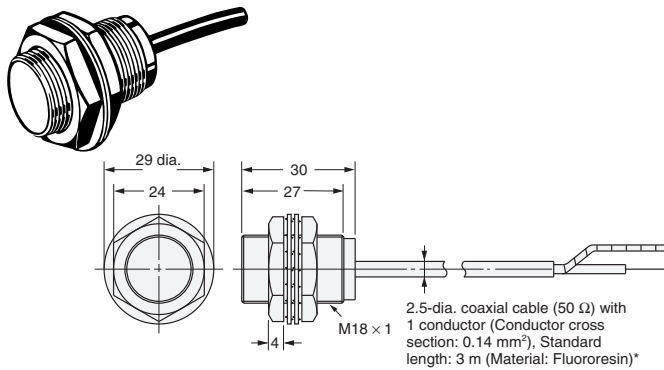

#### E2C-X10A

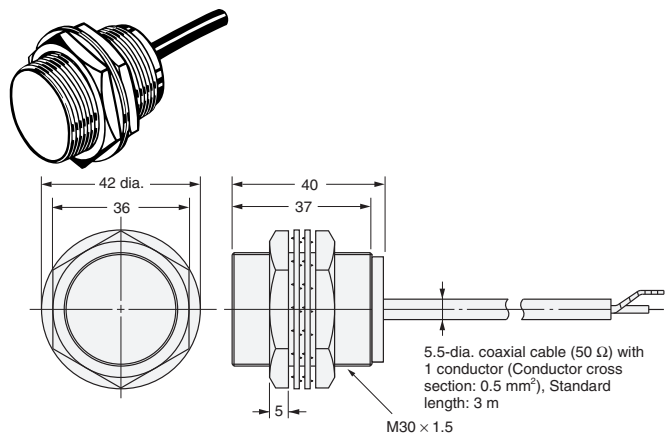

#### E2C-C20MA

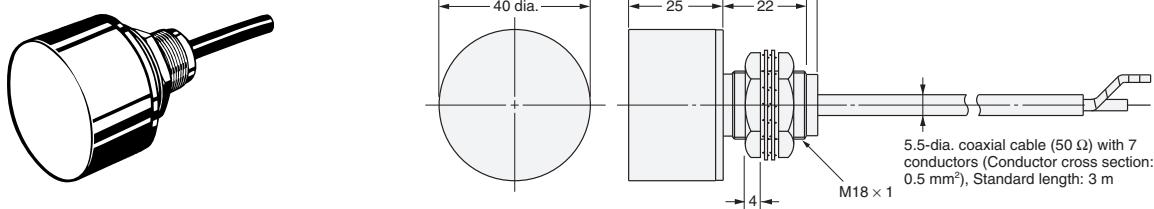

#### Mounting Hole Dimensions

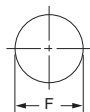

Model	F (mm)	Model	F (mm)	Model	F (mm)
E2C-CR8A	3.7-dia. $^{+0.3}_0$	E2C-X1A	5.4-dia. $^{+0.5}_0$	E2C-X5A	18.5-dia. $^{+0.5}_0$
E2C-CR8B	4.0-dia. $^{+0.3}_0$	E2C-X1R5A	8.5-dia. $^{+0.5}_0$	E2C-X10A	30.5-dia. $^{+0.5}_0$
E2C-C1A	5.7-dia. $^{+0.3}_0$	E2C-X2A	12.5-dia. $^{+0.5}_0$	E2C-C20MA	18.5-dia. $^{+0.5}_0$

## Amplifier Units

### E2C-GE4A E2C-GF4A

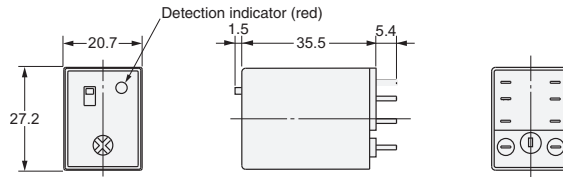
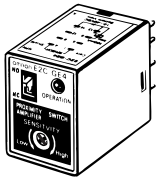

#### Applicable Sockets (Sold Separately)

- PYF08A
- PYF08

#### Hold-down Clip

- PYC-A1

### E2C-AK4A (11-pin) E2C-AM4A (8-pin)

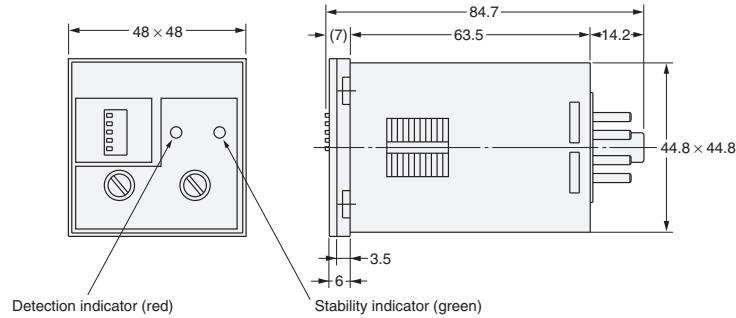
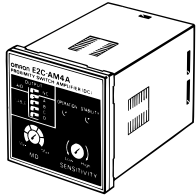

#### Applicable Sockets (Sold Separately)

For E2C-AK4A (11-pin)

- P2CF-11
- P3GA-11

For E2C-AM4A (8-pin)

- P2CF-08
- P3G-08

### E2C-JC4A

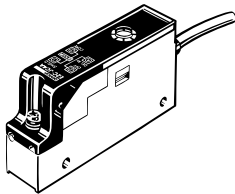

#### Mounting Bracket Installation

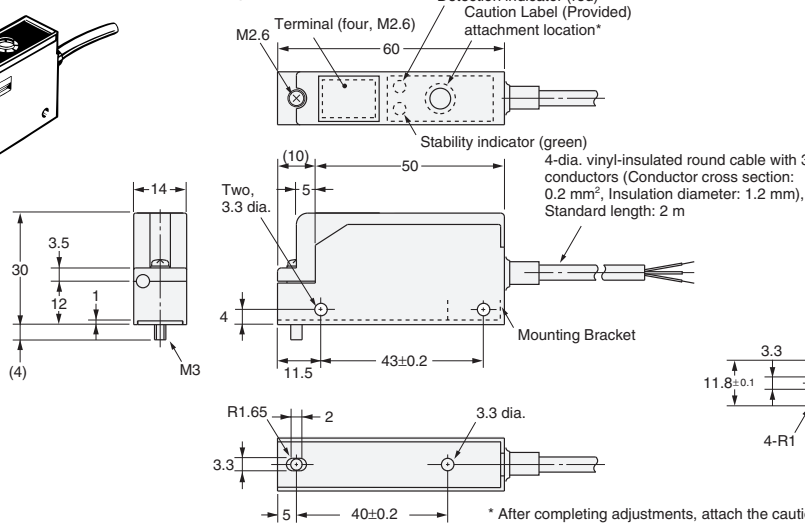

#### Mounting Bracket (Iron)

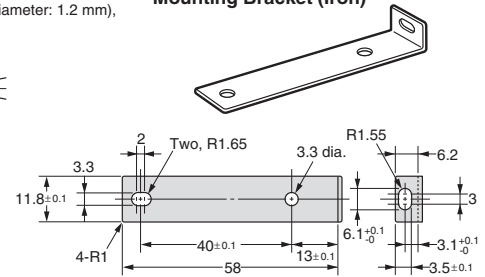

\* After completing adjustments, attach the caution label to prevent adjustment mistakes.

### E2C-JC4AP

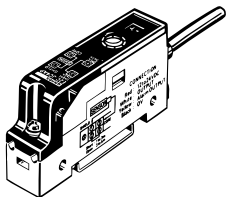

#### Mounting Bracket Installation

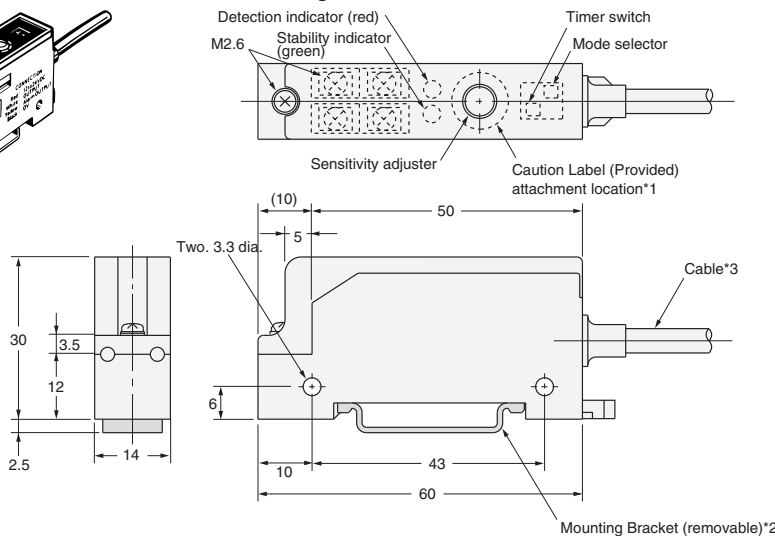

#### Mounting Bracket (Iron)

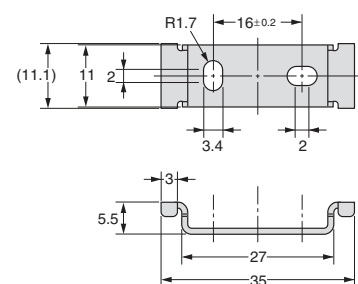

\*1. After completing adjustments, attach the caution label to prevent adjustment mistakes.

\*2. Not required when mounting to DIN Track.

\*3: 4.5-dia. vinyl-insulated round cable with 4 conductors (Conductor cross section: 0.2 mm<sup>2</sup>, Insulator diameter: 1.2 mm), Standard length: 2 m

## E2C-JC4□H

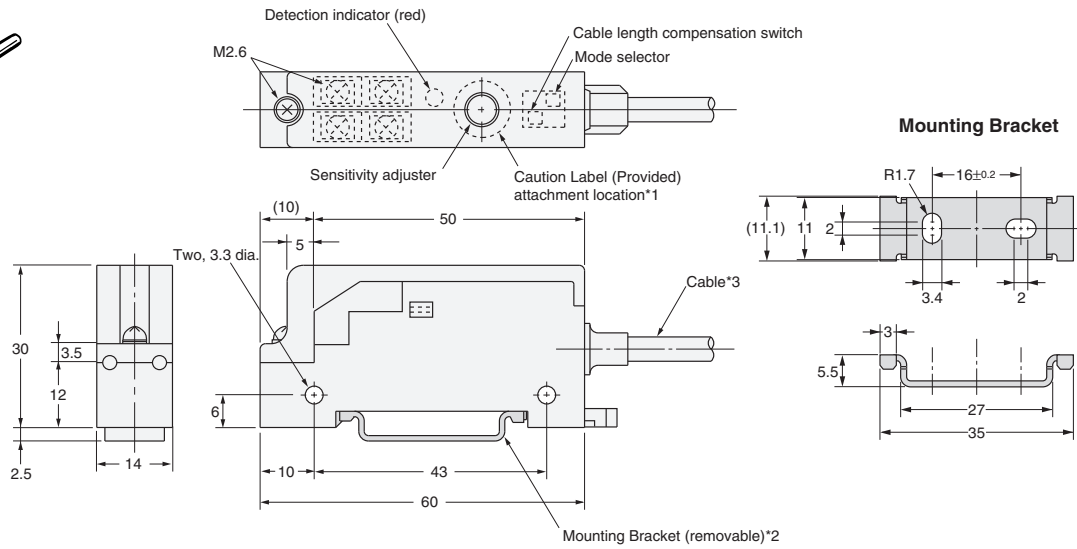
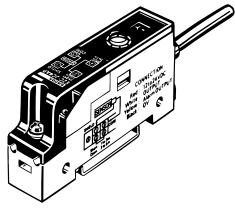

\*1. After completing adjustments, attach the caution label to prevent adjustment mistakes

\*2. Not required when mounting to DIN Track.

\*3. 4-dia. vinyl-insulated round cable with 3 conductors (Conductor cross section:  $0.2 \text{ mm}^2$ , Insulator diameter: 1.2 mm), Standard length: 2 m  
The cable can be extended up to 200 m (separate metal conduit).

Accessories (Order Separately)

Mounting Bracket

Mounting Bracket (for Unthreaded Cylindrical Models)

Y92E-F3R5 (for 3.5 dia.)

Y92E--F5R4 (for 5.4 dia.)

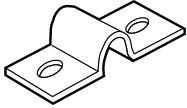

Y92E-F3R5

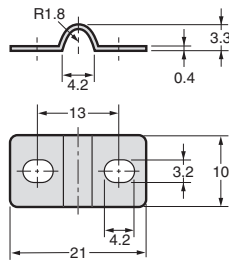

Y92E-F5R4

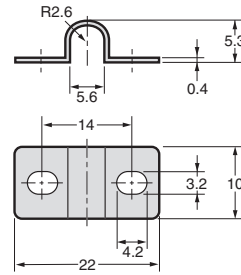

Front Connection Sockets

PYF08A

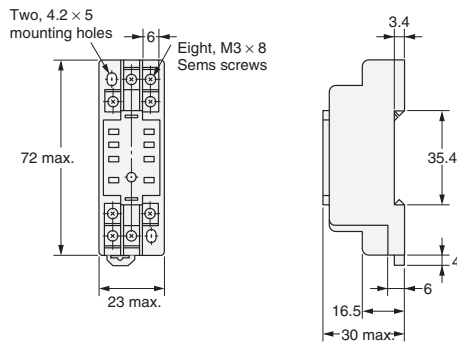
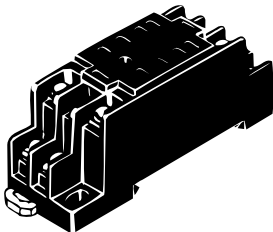

Terminal Arrangement and Internal Connections (Top View)

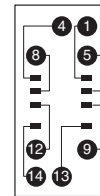

Mounting Hole Dimensions

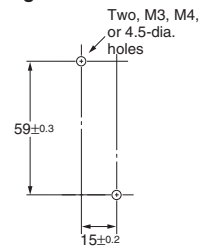

Note: Track mounting is also possible.

P2CF-08

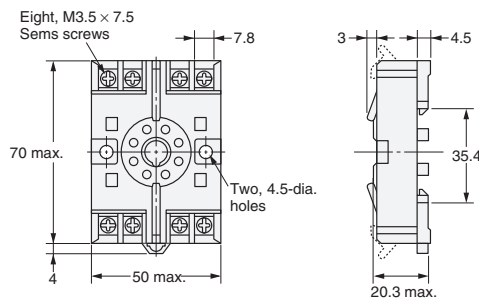
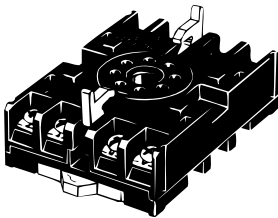

Terminal Arrangement and Internal Connections (Top View)

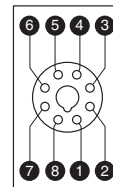

Mounting Hole Dimensions

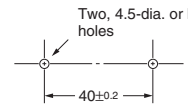

Note: Track mounting is also possible.

P2CF-11

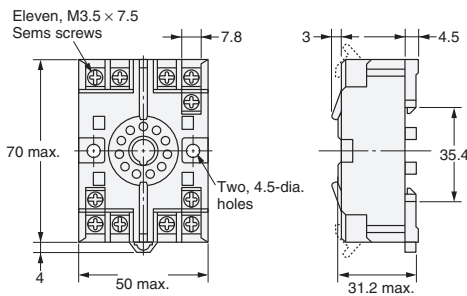
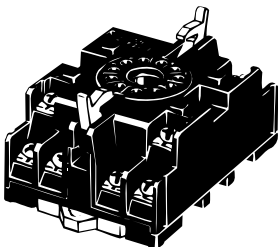

Terminal Arrangement and Internal Connections (Top View)

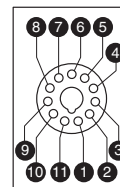

Mounting Hole Dimensions

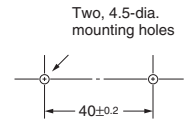

Note: Track mounting is also possible.

Back Connection Sockets

P3G-08

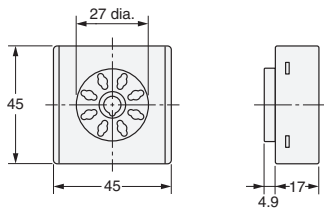
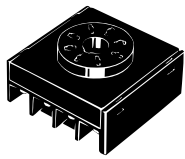

Terminal Arrangement and Internal Connections (Bottom View)

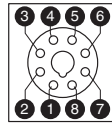

P3GA-11

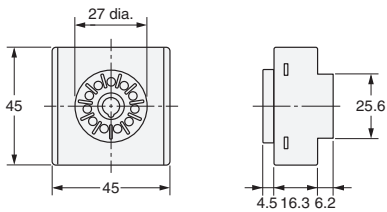
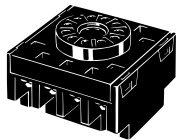

Terminal Arrangement and Internal Connections (Bottom View)

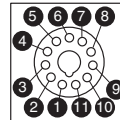

PY08

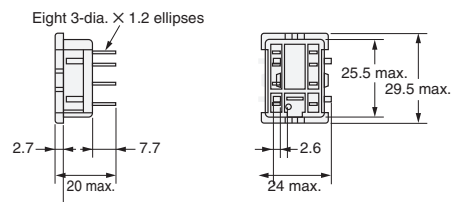
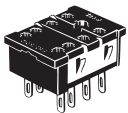

Terminal Arrangement and Internal Connections (Bottom View)

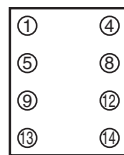

Mounting Holes and PCB Cutout Dimensions

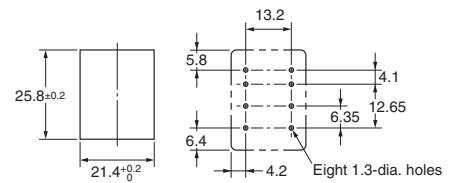

## Embedded Mounting Adapter (for E2C-AK4A/E2C-AM4A Amplifier Unit)

### Y92F-30

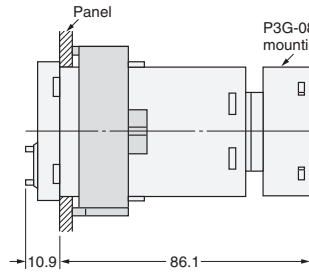
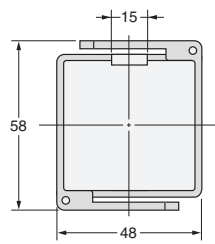
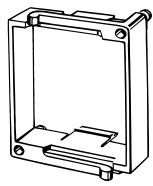

#### Mounting Hole Dimensions

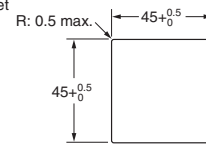

- Note 1. Suitable mounting panel thickness: 1 to 5 mm
- Note 2. Check the direction of the Adapter, which depends on whether Amplifier Units are arranged vertically or horizontally.

### Y92F-70

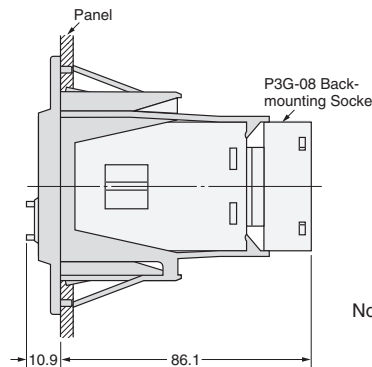
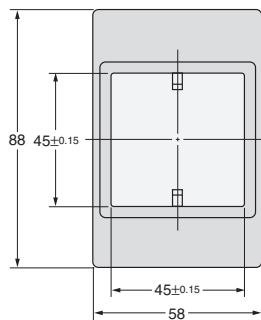
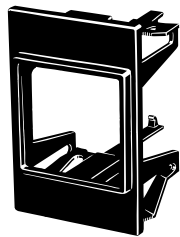

#### Mounting Hole Dimensions

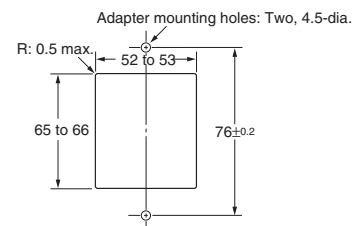

- Note: Suitable mounting panel thickness: 1 to 3.2 mm

### Y92F-71

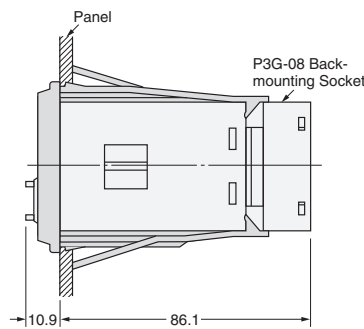
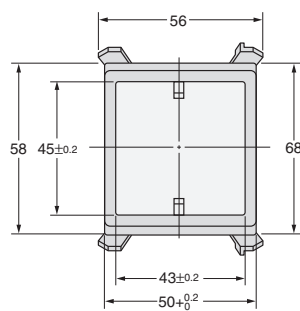
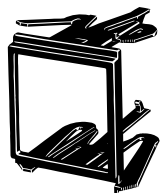

#### Mounting Hole Dimensions

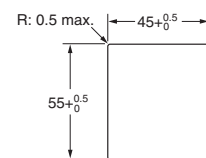

- Note: Suitable mounting panel thickness: 1 to 3.2 mm

## Terms and Conditions Agreement

### Read and understand this catalog.

Please read and understand this catalog before purchasing the products. Please consult your OMRON representative if you have any questions or comments.

### Warranties.

(a) Exclusive Warranty. Omron's exclusive warranty is that the Products will be free from defects in materials and workmanship for a period of twelve months from the date of sale by Omron (or such other period expressed in writing by Omron). Omron disclaims all other warranties, express or implied.

(b) Limitations. OMRON MAKES NO WARRANTY OR REPRESENTATION, EXPRESS OR IMPLIED, ABOUT NON-INFRINGEMENT, MERCHANTABILITY OR FITNESS FOR A PARTICULAR PURPOSE OF THE PRODUCTS. BUYER ACKNOWLEDGES THAT IT ALONE HAS DETERMINED THAT THE PRODUCTS WILL SUITABLY MEET THE REQUIREMENTS OF THEIR INTENDED USE.

Omron further disclaims all warranties and responsibility of any type for claims or expenses based on infringement by the Products or otherwise of any intellectual property right. (c) Buyer Remedy. Omron's sole obligation hereunder shall be, at Omron's election, to (i) replace (in the form originally shipped with Buyer responsible for labor charges for removal or replacement thereof) the non-complying Product, (ii) repair the non-complying Product, or (iii) repay or credit Buyer an amount equal to the purchase price of the non-complying Product; provided that in no event shall Omron be responsible for warranty, repair, indemnity or any other claims or expenses regarding the Products unless Omron's analysis confirms that the Products were properly handled, stored, installed and maintained and not subject to contamination, abuse, misuse or inappropriate modification. Return of any Products by Buyer must be approved in writing by Omron before shipment. Omron Companies shall not be liable for the suitability or unsuitability or the results from the use of Products in combination with any electrical or electronic components, circuits, system assemblies or any other materials or substances or environments. Any advice, recommendations or information given orally or in writing, are not to be construed as an amendment or addition to the above warranty.

See <http://www.omron.com/global/> or contact your Omron representative for published information.

### Limitation on Liability: Etc.

OMRON COMPANIES SHALL NOT BE LIABLE FOR SPECIAL, INDIRECT, INCIDENTAL, OR CONSEQUENTIAL DAMAGES, LOSS OF PROFITS OR PRODUCTION OR COMMERCIAL LOSS IN ANY WAY CONNECTED WITH THE PRODUCTS, WHETHER SUCH CLAIM IS BASED IN CONTRACT, WARRANTY, NEGLIGENCE OR STRICT LIABILITY.

Further, in no event shall liability of Omron Companies exceed the individual price of the Product on which liability is asserted.

### Suitability of Use.

Omron Companies shall not be responsible for conformity with any standards, codes or regulations which apply to the combination of the Product in the Buyer's application or use of the Product. At Buyer's request, Omron will provide applicable third party certification documents identifying ratings and limitations of use which apply to the Product. This information by itself is not sufficient for a complete determination of the suitability of the Product in combination with the end product, machine, system, or other application or use. Buyer shall be solely responsible for determining appropriateness of the particular Product with respect to Buyer's application, product or system. Buyer shall take application responsibility in all cases.

NEVER USE THE PRODUCT FOR AN APPLICATION INVOLVING SERIOUS RISK TO LIFE OR PROPERTY OR IN LARGE QUANTITIES WITHOUT ENSURING THAT THE SYSTEM AS A WHOLE HAS BEEN DESIGNED TO ADDRESS THE RISKS, AND THAT THE OMRON PRODUCT(S) IS PROPERLY RATED AND INSTALLED FOR THE INTENDED USE WITHIN THE OVERALL EQUIPMENT OR SYSTEM.

### Programmable Products.

Omron Companies shall not be responsible for the user's programming of a programmable Product, or any consequence thereof.

### Performance Data.

Data presented in Omron Company websites, catalogs and other materials is provided as a guide for the user in determining suitability and does not constitute a warranty. It may represent the result of Omron's test conditions, and the user must correlate it to actual application requirements. Actual performance is subject to the Omron's Warranty and Limitations of Liability.

### Change in Specifications.

Product specifications and accessories may be changed at any time based on improvements and other reasons. It is our practice to change part numbers when published ratings or features are changed, or when significant construction changes are made. However, some specifications of the Product may be changed without any notice. When in doubt, special part numbers may be assigned to fix or establish key specifications for your application. Please consult with your Omron's representative at any time to confirm actual specifications of purchased Product.

### Errors and Omissions.

Information presented by Omron Companies has been checked and is believed to be accurate; however, no responsibility is assumed for clerical, typographical or proofreading errors or omissions.