

Push-in fittings QSM, mini

FESTO



Festo Core Range
Solves the majority of your automation tasks

Worldwide: Quickest delivery – wherever, whenever
Simply good: Expected high Festo quality
Fast: Easy and fast to select

With the Festo Core Range, we have selected the most important products and functions from our broad product catalogue, and added the quickest delivery.

The Core Range offers you the best value for your automation tasks.

Just look
for the
star!

Key features

Application



Choosing the right fitting is effortless. Festo offers the right solution for every connection. With far more than 1000 types of standard and function fittings, Festo offers a secure solution for every connection.

Overview of tubing/fitting combinations

Applications	Fitting	Tubing	Description
Standard	QS(M)	PUN-H	Maximum flexibility in standard applications thanks to an extremely wide range of options for combining the different types.
	QS(M)	PEN	Suitable for a wide range of tasks and attractively priced. Flexible with highly resistant materials, easy to install with optimised bending radii. High level of abrasion resistance in dynamic applications.
	QS(M)	PAN	Meets all requirements, even for standard applications with increased pressure and temperature ranges.
High pressures	NPQM	PAN-MF	Meets DIN standard 73378: ideal for use in mobile pneumatics. Suitable for increased temperature ranges combined with high pressure ranges.
	NPQH	PAN-R	High performance in pressure ranges up to 20 bar, for example in applications with the pressure booster DPA.
Resistant to chemicals, food-safe and hydrolysis-resistant	NPQP	PLN	Resistant to cleaning agents, FDA-compliant and economical. Can be used instead of the combination with stainless steel fittings.
	NPKA	PUN-H	Hydrolysis-resistant and suitable for water applications. Combination suitable for use in clean rooms, FDA-compliant and corrosion resistant, made of 100% polymer. Very easy to install with the "one click principle".
	NPQH	PFAN/PTFEN	For high temperatures up to 150°C. Food-safe, FDA-compliant and resistant to cleaning agents.
	NPCK	PFAN/PTFEN	Easy to clean thanks to the union nut's edge-free design. Maximum resistance to corrosion (CRC 4) and FDA-compliant. Suitable for a wide range of media.
	CRQS	PFAN/PTFEN	Maximum resistance to corrosion (CRC 4) and to aggressive acids and alkalis.
Resistant to chemicals and hydrolysis	NPQR	PFAN/PTFEN	Optimised design, fewer edges where dirt can collect – all at an attractive price. For high temperatures up to 150°C. Pressure range up to 16 bar. Highest level of corrosion resistance (CRC 4).
Antistatic	NPQM	PUN-CM	Antistatic tubing plus solid metal fitting: maximum protection for electric and electronic components.
Flame-retardant	NPQM	PUN-V0	Very safe in areas where there is a risk of fire with its flame-retardant properties. The tubing has been tested to DIN 5510-2.
Resistant to welding spatter	NPQH	PUN-V0-C	Ideal for applications involving welding spatter. Reliable with tubing wall thickness of 2 mm for all diameters.
	QS-V0	PAN-V0	Safe even in the close vicinity of welding spatter with the double-walled tubing with special fitting.

Key features

Push-in fittings product range

QSM, mini

Datasheets → Internet: qsm



Miniature push-in fittings for maximum component density in confined spaces. For pneumatic applications with a temperature range up to 80°C and a pressure range up to 14 bar. Tubing O.D. 2, 3, 4 and 6 mm with connecting thread M3, M5, M6, M7, R1/8 and G1/8.

QS, standard

Datasheets → Internet: qs



Wide selection of push-in fittings for pneumatic applications with a temperature range up to 80°C and a pressure range up to 14 bar. Tubing O.D. 4, 6, 8, 10, 12, 16 and 22 mm with connecting thread R1/8 ... R1/2 and G1/8 ... G3/4.

CRQS, stainless steel

Datasheets → Internet: crqs



Stainless steel push-in fitting. Extremely high corrosion resistance (CRC 4) and chemical resistance with approval for use in the food and packaging industry. For pneumatic applications with a temperature range up to 120°C and a pressure range up to 10 bar. Tubing O.D. 4, 6, 8, 10, 12 and 16 mm with connecting thread M5 and R1/8 ... R1/2.

QS-V0, resistant to welding spatter

Datasheets → Internet: qs-v0



Flame-retardant push-in fitting for use in all areas where there is a risk of fire, for example welding systems in the automotive industry, and in the construction industry. For pneumatic applications with a temperature range up to 60°C and a pressure range up to 10 bar. Tubing O.D. 4, 6, 8, 10 and 12 mm with connecting thread R1/8 ... R1/2 and G1/8 ... G1/2.

NPQH

Datasheets → Internet: npqh



All metal push-in fitting made of chemically nickel-plated brass. High corrosion resistance CRC 3 and chemical resistance. For pneumatic applications with a temperature range up to 150°C and a pressure range up to 20 bar. Tubing O.D. 4, 6, 8, 10, 12 and 14 mm with connecting thread M5, M7 and G1/8 ... G1/2.

NPQM

Datasheets → Internet: npqm



Attractively priced metal push-in fitting for pneumatic applications with a temperature range up to 70°C and a pressure range up to 16 bar. Tubing O.D. 3, 4, 6, 8, 10, 12 and 14 mm with connecting thread M5, M7 and G1/8 ... G1/2.

NPQP

Datasheets → Internet: npqp



Polypropylene fitting for use in applications with extreme media influences. For pneumatic applications with a temperature range up to 60°C and a pressure range up to 10 bar. Tubing O.D. 4, 6, 8, 10 and 12 mm with connecting thread R1/8 ... R1/2.

NPQR, stainless steel

Datasheets → Internet: npqr



Stainless steel push-in fitting. Maximum corrosion resistance CRC 4 and chemical resistance. For pneumatic applications with a temperature range up to 150°C and a pressure range up to 16 bar. Tubing O.D. 4, 6, 8, 10 and 12 mm with connecting thread M5, M7 and G1/8 ... G1/2.

Key features

Functional push-in fittings product range

QSK,
push-in fitting, self-sealing

Datasheets → Internet: qsk



Push-in fitting that blocks the air flow after the tubing is disconnected. For pneumatic applications with a temperature range up to 60°C and a pressure range up to 14 bar.

Tubing O.D. 4, 6, 8, 10 and 12 mm with connecting thread M5, R1/8 ... R1/2 and G1/8 ... G1/2.

QSR,
push-in fitting, rotatable

Datasheets → Internet: qsr



Push-in fitting with swivel joint, rotatable by 360°. The ball bearing enables rotating movements in the application up to max. 500 rpm. For pneumatic applications with a temperature range up to 60°C and a pressure range up to 14 bar.

Tubing O.D. 4, 6, 8, 10 and 12 mm with connecting thread M5, R1/8 ... R1/2 and G1/8 ... G1/2.

Quick connectors product range

NPCK

Datasheets → Internet: npck



Stainless steel fitting for use in areas subject to intensive cleaning. Extremely high corrosion resistance (CRC 4). For pneumatic applications with a temperature range up to 120°C and a pressure range up to 12 bar.

Tubing O.D. 4, 6, 8 and 10 mm with connecting thread M5 and G1/8 ... G3/8.

Click fittings product range

NPKA

Datasheets → Internet: npka



Plastic fitting for easy installation with one hand. Hydrolysis-resistant, FDA-compliant and easy to clean. For pneumatic applications with a temperature range up to 60°C and a pressure range up to 10 bar.

Tubing O.D. 6 mm with connecting thread G1/8.

Simply "plug and work"

The stainless steel retaining claw holds the tubing securely without damaging its surface. Vibration and pressure surges are absorbed.

Reliably connected

A nitrile rubber sealing ring guarantees a perfect seal between standard tubing and the body of the fitting.

The standard O.D. tubing combined with the Festo push-in connector is suitable for compressed air and vacuum.

The captive seal

All brass parts of Festo's push-in fittings have nickel-plated surfaces and are thus highly resistant to corrosion. The tapered ISO R threads have a self-sealing PTFE coating, which allows the fitting to be re-used up to five times without the need for additional sealing components.

Rotatable

The fittings can be aligned after they have been mounted.

Key features

Which fitting fits which thread?

Metric thread

- Threads are comparable with G threads and are fitted as cylindrical metric thread
- Sealing is guaranteed as the O-ring sits in a groove that seals against the tube.

G thread to ISO 228-1

- Shorter thread
- Constant installation depth
- Replaceable sealing ring
- Sealing on front face
- Can be re-used a number of times thanks to replaceable sealing ring.

R thread to EN 10226-1 and ISO 7/1

- Self-sealing thread
- Sealing via coated threads
- No additional sealing surface required
- Smaller installation dimensions since there is no need for an offset for the sealing surface
- Can be reused up to 5 times.

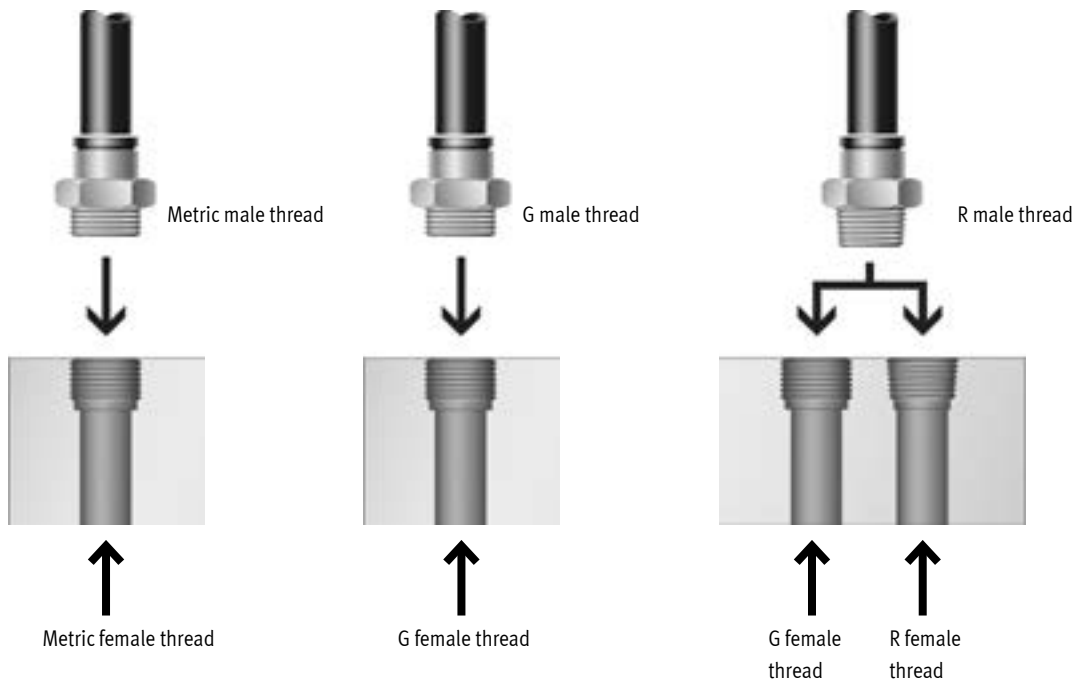

Note

All R threads are coated with a sealing material. This coating replaces the conventional sealing ring. Simply screw in the R thread by hand and tighten 1 or 2 revolutions with an open-end spanner. The fitting can be reinstalled up to five times.

When screwing in R threads several times, you must make sure that the abraded particles from the sealing material coating cannot enter the compressed air system.

Tube mounting/dismounting

Mounting

The prerequisite for ensuring that the inside seal is securely held and protected against damage is that the tube is cut into straight lengths and deburred.

- 1) Insert tubing as far as the stop.
It is important to ensure that the tubing is inserted into the inner seal. Depending on the tolerance between the tubing and the seal, the contact of the tubing with the seal may be wrongly interpreted as the stop.
- 2) Check that the tubing connection is secure by pulling gently on the tube.

Dismounting

- 1) The tubing can be detached easily by pressing and holding down the releasing ring. Remove the tubing carefully from the fitting.
- 2) Before re-using the tubing, remove the damaged part by cutting it off.

Technical data

General technical data	
Design	Push-pull principle
Mounting position	Any
Type of seal on screwed trunnion	Sealing ring for M/G thread Coating for R thread
Nominal tightening torque [Nm]	0.48 ±55% for M3 male thread 1.33 ±20% for M5 male thread 3.55 ±20% for M7 male thread 7 ±20% with G1/8 male thread
Tubing insertion depth ¹⁾ [mm]	8.4 for tubing O.D. 2 mm 9.5 for tubing O.D. 3 mm 11.5 for tubing O.D. 4 mm 12 for tubing O.D. 6 mm

1) The indicated tubing insertion depths are reference values and may vary slightly depending on the type.

Note

When using push-in fittings with internal hex, ensure that the Allen key is not inserted too far into the fitting when tightening, to prevent the risk of damage to components behind the fitting.

Operating and environmental conditions	
Operating pressure for entire temperature range [bar]	-0.95 ... +6
Temperature-dependent operating pressure [bar]	-0.95 ... +14 → graph
Operating medium	Compressed air to ISO 8573-1:2010 [7:-:-]
Note on the operating/pilot medium	Lubricated operation possible
Ambient temperature [°C]	-10 ... +80
Corrosion resistance class CRC ²⁾	1
Maritime classification	See certificate ¹⁾

1) Additional information: www.festo.com/catalogue/... → Support/Downloads.

2) Corrosion resistance class CRC 1 to Festo standard FN 940070

Low corrosion stress. Dry internal application or transport and storage protection. Also applies to parts behind covers, in the non-visible interior area, or parts which are covered in the application (e.g. drive trunnions).

Operating pressure p as a function of temperature t

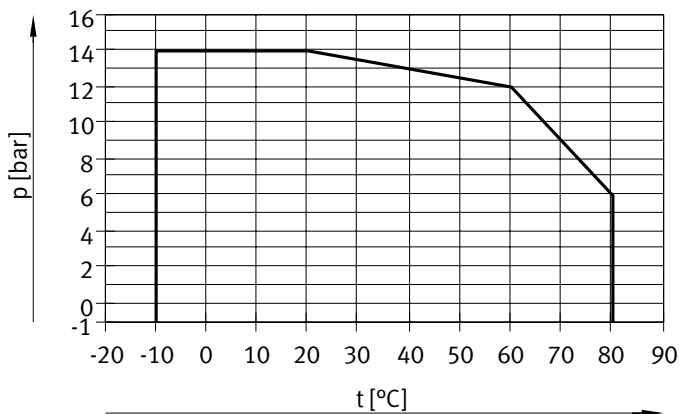

Technical data

Materials

Sectional view

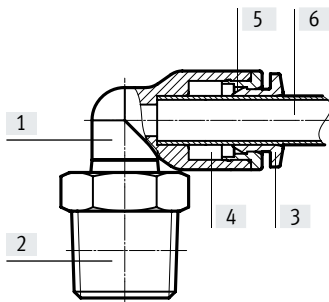

Type	QSM, mini
[1] Housing	Nickel-plated brass, PBT QSM-M3-3/4: Nickel-plated steel
[2] Screwed trunnion	Nickel-plated brass M3: Nickel-plated steel
[3] Releasing ring	POM (colour: blue)
[4] Tubing seal	NBR
[5] Tube clamping segment	High-alloy stainless steel
[6] Plastic tubing, standard O.D.	PUN-H, PEN, PAN
Note on materials	RoHS-compliant













Possible push-in fitting/tubing combinations

Thread	Tubing O.D. [mm]			
	2	3	4	6
M3	+	++	+	-
M5	+	+	++	+
M6	-	-	-	+
M7	-	-	+	++
M8	-	-	-	++
R1/8	-	-	+	++
G1/8	-	-	+	++













+ Possible thread/tubing O.D. combinations

++ Optimum thread/tubing O.D. combination (for the flow rate)



Product range overview

Design	Version	Type	Connection D1				Push-in sleeve \varnothing	Connection D2		→ Page/ Internet
			M thread	R thread	G thread	Tubing O.D.		Tubing O.D.		
Straight shape	Push-in fitting – male thread with external hex									
		QSM	M3	–	–	–	–	2, 3, 4	11	
			M5					2, 3, 4, 6		
			M6					6		
		QSM	–	R1/8	G1/8	–	–	4, 6	11	
	Push-in fitting – male thread with internal hex									
		QSM-...-I	M3	–	–	–	–	2, 3, 4	12	
			M5					3, 4, 6		
			M7	R1/8	G1/8			4, 6		
	Push-in fitting – male thread with internal hex, round releasing ring									
		QSM-...-I-R	M3	–	–	–	–	3, 4	13	
			M5					3, 4, 6		
			M7					6		
	Push-in fitting – female thread with external hex									
		QSMF	M3	–	–	–	–	3, 4	14	
			M5					3, 4		
	Push-in fitting – male thread with internal hex									
		QSMP	M6x0.75	–	–	–	–	4	14	
			M8x0.75					6		
			M8x1.25					6		
Push-in connector										
	QSM	–	–	–	3	–	3	15		
		4					4			
		6					6			
	QSM Reducing	–	–	–	3	–	2	15		
		4					3			
		6					4			
Push-in bulkhead connector										
	QSMS	–	–	–	3	–	–	15		
		4								
		6								
Push-in cap										
	QSMC	–	–	–	3	–	–	16		
Push-in connector with push-in sleeve										
	QSM-...H	–	–	–	–	3	2	16		
		4					3			
		6					4			
Blanking plug										
	QSMC-...H	–	–	–	–	2	–	16		
		3								

Product range overview

Design	Version	Type	Connection D1				Push-in sleeve \varnothing	Connection D2		→ Page/ Internet
			M thread	R thread	G thread	Tubing O.D.		Tubing O.D.		
L-shape	Push-in L-fitting – male thread with external hex, rotatable									
		QSML	M3	–	–	–	–	2, 3, 4	17	
			M5					2, 3, 4, 6		
			M7	R1/8	G1/8			4, 6		
	Push-in L-fitting, long – male thread with external hex, rotatable									
		QSMLL	M3	–	–	–	–	2, 3, 4	18	
			M5					2, 3, 4, 6		
			M7	R1/8	G1/8			4, 6		
	Push-in L-fitting – male thread with internal hex, rotatable									
		QSMLV-...-I	M5	–	–	–	–	3, 4	19	
			M7					4, 6		
	Push-in L-fitting, long – male thread with internal hex, rotatable									
	QSMLLV-...-I	M5	–	–	–	–	3, 4	19		
		M7					4, 6			
Push-in L-connector										
	QSML	–	–	–	3	–	–	20		
		4								
		6								
Push-in L-connector with push-in sleeve										
	QSML-...H	–	–	–	–	3	3	20		
		4					4			
		6					6			
	QSML-...H Reducing	–	–	–	–	4	3	20		
		6					4			
T-shape	Push-in T-fitting – male thread with external hex, rotatable									
		QSMT	M3	–	–	–	–	3, 4	21	
			M5					3, 4, 6		
			–	R1/8	G1/8			4, 6		
		QSMTL	M3	–	–	–	–	3, 4	22	
			M5					3, 4, 6		
	–		R1/8	G1/8			4, 6			
Push-in T-connector										
	QSMT	–	–	–	2	–	2	23		
		3					3			
		4					4			
		6					6			
	QSMT Reducing	–	–	–	4	–	3	23		
		6					4			
X shape	Push-in X-connector									
		QSMX	–	–	–	3	–	–	24	
			4							
	6									

Product range overview

Design	Version	Type	Connection D1				Connection D2		→ Page/ Internet
			M thread	R thread	G thread	Tubing O.D.	Push-in sleeve ∅	Tubing O.D.	
Y-shape	Push-in Y-connector								
		QSMY	-	-	-	2	-	2	24
						3		3	
						4		4	
						6		6	
		QSMY Reducing	-	-	-	4	-	3	24
6						4			
Releasing tool	Quick-Out releasing tool for push-in connections								
		QSO							25

Datasheet

Push-in fitting QSM

Male thread with external hex



M thread

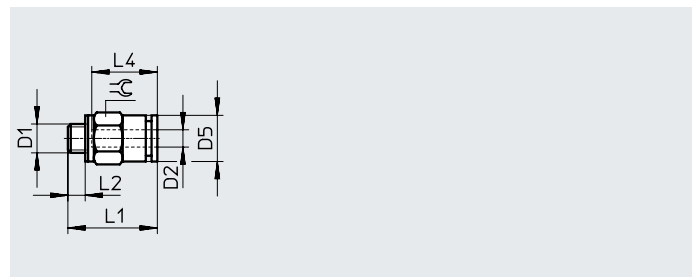

R thread

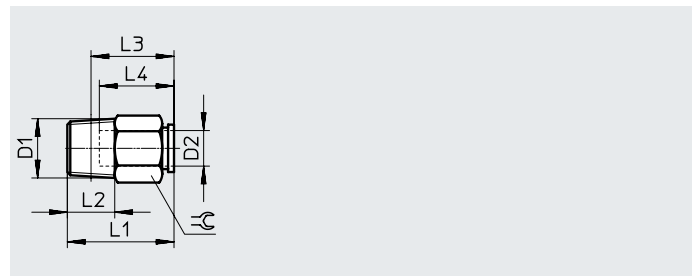

G thread

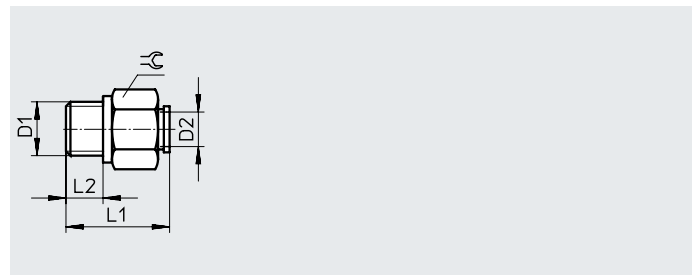

Dimensions and ordering data													
Pneumatic connection		Nominal width [mm]	Dimensions [mm]							Weight/ piece [g]	Part no.	Type	Pcs. ¹⁾
Male thread	For tubing O.D.		D5	L1	L2	L3	L4	⌀					
D1	D2												
Metric thread with sealing ring													
M3	2	0.9	4.8	12.1	2.5	-	8.4	5	1	133027	QSM-M3-2	10	
	3		7	13.3	2.5	-	9.6	5.5	1.1	153301	QSM-M3-3	10	
	4	1.1	9.8	15.7	2.5	-	11.5	8	2.4	★ 153303	QSM-M3-4	10	
										130776	QSM-M3-4-100	100	
M5	2	1.1	4.8	11.8	3	-	8.4	7	2.2	133028	QSM-M5-2	10	
	3	2	9.8	16.2	3	-	11.5	8	3.4	153302	QSM-M5-3	10	
										130777	QSM-M5-3-100	100	
	4	2.2	9.8	16.2	3	-	11.5	8	3.2	★ 153304	QSM-M5-4	10	
										130778	QSM-M5-4-100	100	
6	2.1	11.8	17.3	3	-	12	10	4.5	★ 153306	QSM-M5-6	10		
										130779	QSM-M5-6-100	100	
M6	6	2.8	11.8	18	3.9	-	11.7	10	4.8	★ 132600	QSM-M6-6	10	
R thread													
R1/8	4	2.9	-	16	8	12	11.5	10	6	★ 153305	QSM-1/8-4	10	
										130755	QSM-1/8-4-100	100	
	6	4.5	-	18	8	14	12	10	6	★ 153307	QSM-1/8-6	10	
										130756	QSM-1/8-6-100	100	
G thread with sealing ring													
G1/8	4	2.9	-	16.4	5.1	-	-	13	9.4	★ 186264	QSM-G1/8-4	10	
	6	2.8	-	18.4	5.1	-	-	13	11	★ 186265	QSM-G1/8-6	10	

1) Pack size

Datasheet

Push-in fitting QSM-...-I

Male thread with internal hex

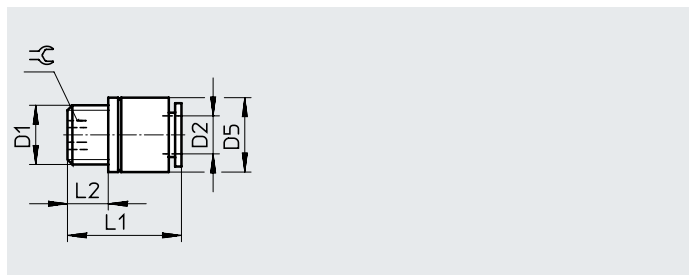
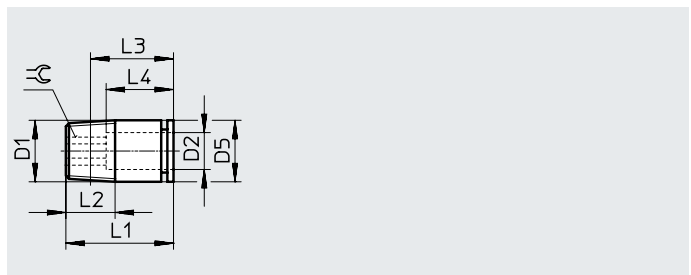
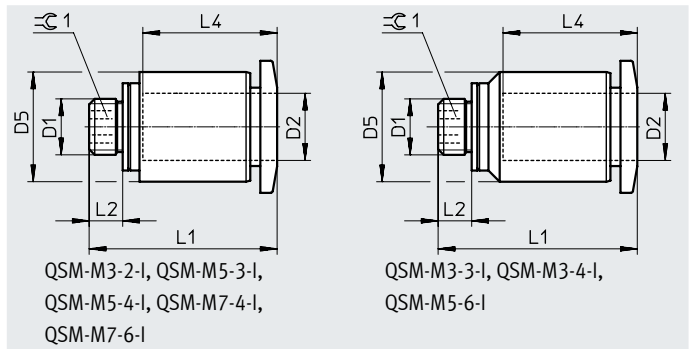

Dimensions and ordering data

Pneumatic connection		Nominal width	Dimensions [mm]						Weight/ piece	Part no.	Type	Pcs. ¹⁾
Male thread	For tubing O.D.		D5	L1	L2	L3	L4	☉				
D1	D2	[mm]	∅						[g]			
Metric thread with sealing ring												
M3	2	1.1	5	12.1	2.5	-	8.4	1.3	0.8	133026	QSM-M3-2-I	10
	3	1.6	8	15.7	2.5	-	11.5	1.5	2.3	153312	QSM-M3-3-I	10
	4	1.5	8	15.7	2.5	-	11.5	1.5	2.2	★ 153314	QSM-M3-4-I	10
M5	3	1.9	8	16.2	3	-	11.5	2	3.2	153313	QSM-M5-3-I	10
	4	2.5	8	16.2	3	-	11.5	2.5	3	★ 153315	QSM-M5-4-I	10
	6	2.6	9.8	17.8	3	-	12	2.5	4.4	★ 153317	QSM-M5-6-I	10
M7	4	3.1	9.8	18.9	5.5	-	11.5	3	6	★ 153319	QSM-M7-4-I	10
										133006	QSM-M7-4-I-100	100
	6	4.1	9.8	20.9	5.5	-	12	4	6.4	★ 153321	QSM-M7-6-I	10
R thread												
R1/8	4	3.1	10	16.4	8	12.4	11.5	3	6.2	★ 153316	QSM-1/8-4-I	10
	6	4.1	10	18.2	8	14.2	12.5	4	5.6	★ 153318	QSM-1/8-6-I	10
G thread with sealing ring												
G1/8	4	3.1	13	16.4	5.1	-	-	3	8.9	★ 186266	QSM-G1/8-4-I	10
	6	4.1	13	18.4	5.1	-	-	4	9.5	★ 186267	QSM-G1/8-6-I	10

1) Pack size

Datasheet

Push-in fitting QSM-...-I-R
Male thread with internal hex
Round releasing ring

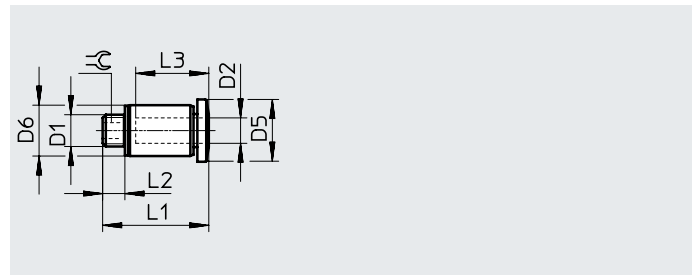

Dimensions and ordering data												
Pneumatic connection		Nominal width [mm]	Dimensions [mm]						Weight/ piece [g]	Part no.	Type	Pcs. ¹⁾
Male thread	For tubing O.D.		D5 ∅	D6 ∅	L1	L2	L3	≈				
D1	D2											
Metric thread with sealing ring, round releasing ring												
M3	3	1.6	6	5.5	13.3	2.5	9.6	1.5	2.3	133001	QSM-M3-3-I-R	10
	4	1.5	7.8	8	15.7	2.5	11.5	1.5	2.2	132914	QSM-M3-3-I-R-100	100
										133002	QSM-M3-4-I-R	10
										132915	QSM-M3-4-I-R-100	100
M5	3	1.9	7.8	8	16.2	3	11.5	2	3.2	133003	QSM-M5-3-I-R	10
	4	2.5	7.8	8	16.2	3	11.5	2.5	3	132916	QSM-M5-3-I-R-100	100
										133004	QSM-M5-4-I-R	10
										132917	QSM-M5-4-I-R-100	100
										133005	QSM-M5-6-I-R	10
									132918	QSM-M5-6-I-R-100	100	
M7	6	4.1	9.8	9.8	20.9	5.5	12	4	6.4	133007	QSM-M7-6-I-R	10
										132919	QSM-M7-6-I-R-100	100

1) Pack size

Datasheet

Push-in fitting QSMF

Female thread with external hex

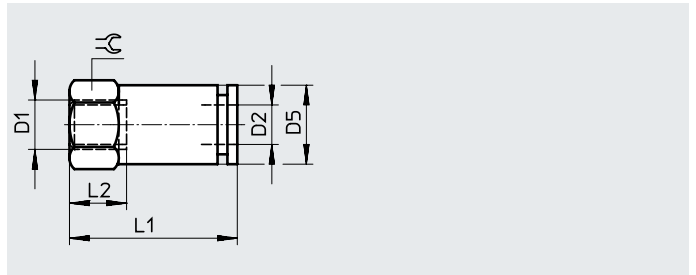

Dimensions and ordering data

Pneumatic connection		Nominal width [mm]	Dimensions [mm]				Weight/ piece [g]	Part no.	Type	Pcs. ¹⁾
Female thread	For tubing O.D.		D5 ∅	L1	L2	⊕				
D1	D2									

Metric thread with sealing ring

M3	3	1.3	5.5	13.9	4.4	5.5	1.6	153308	QSMF-M3-3	10
	4	2.1	8	16	4.5	8	4.1	153310	QSMF-M3-4	10
M5	3	1.9	8	15.5	4.5	8	4.3	153309	QSMF-M5-3	10
	4	1.8	8	18.2	4.5	8	4.5	153311	QSMF-M5-4	10

1) Pack size

Push-in fitting QSMP

Male thread with internal hex

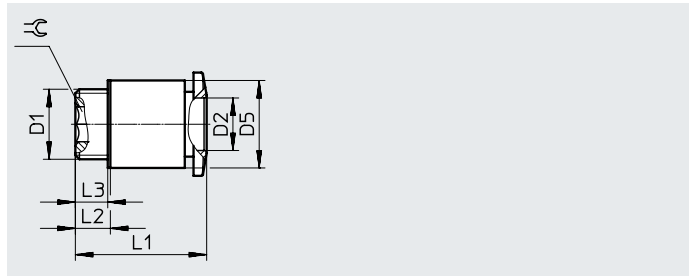

Dimensions and ordering data

Pneumatic connection		Nominal width [mm]	Dimensions [mm]				Weight/ piece [g]	Part no.	Type	Pcs. ¹⁾
Male thread	For tubing O.D.		D5 ∅	L1	L2	L3				
D1	D2									

Metric thread with sealing ring

M6x0.75	4	2.5	8	14.6	3.5	3	2.5	2.7	153320	QSMP-M6X0.75-4	10
M8x0.75	6	4	10	15.1	4	3.4	4	3.7	153322	QSMP-M8X0.75-6	10
M8x1.25	6	4	10	19.1	7	6.4	4	4.7	154434	QSMP-M8X1.25-6	10

1) Pack size

Datasheet

Push-in connector QSM

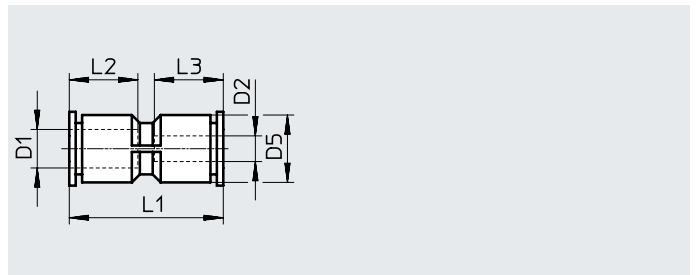

Dimensions and ordering data										
Pneumatic connection		Nominal width [mm]	Dimensions [mm]				Weight/ piece [g]	Part no.	Type	Pcs. ¹⁾
For tubing O.D.	For tubing O.D.		D5 ∅	L1	L2	L3				
D1	D2									
3	3	1.9	6	20	9.5	9.5	1.5	153323	QSM-3	10
								130757	QSM-3-100	100
4	4	2.6	8	23.5	11.5	11.5	2	★ 153324	QSM-4	10
								130758	QSM-4-100	100
6	6	3.7	10.5	25	12	12	4	★ 153325	QSM-6	10
								130759	QSM-6-100	100
Reducing										
3	2	1.1	6	19.1	9.3	8.4	1	133029	QSM-3-2	10
4	3	1.7	8	23.9	11.6	11.6	2.1	★ 153326	QSM-4-3	10
								130760	QSM-4-3-100	100
6	4	2.7	10.4	24.9	11.6	11.6	3	★ 153327	QSM-6-4	10
								130761	QSM-6-4-100	100

1) Pack size

Push-in bulkhead connector QSMS

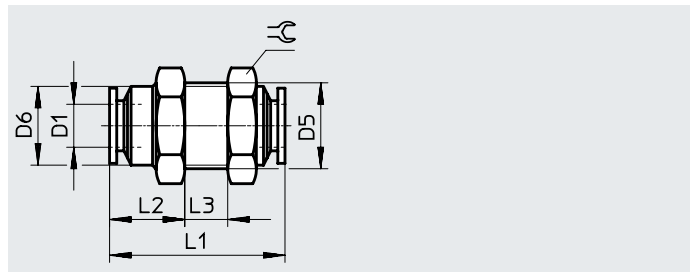

Dimensions and ordering data												
Pneumatic connection		Nominal width [mm]	Dimensions [mm]					Weight/ piece [g]	Part no.	Type	Pcs. ¹⁾	
For tubing O.D.	For tubing O.D.		D5	D6 ∅	L1	L2	L3 max.					⊕
D1												
3		1.7	M8x0.75	7	19.5	7	7.5	10	3	153375	QSMS-3	10
4		2.2	M10x1	9	24	9.5	7.5	12	6	★ 153376	QSMS-4	10
										130780	QSMS-4-100	100
6		3.7	M12x1	11	25	11	6	14	9	★ 153377	QSMS-6	10
										130781	QSMS-6-100	100

1) Pack size

Datasheet

Push-in cap QSMC

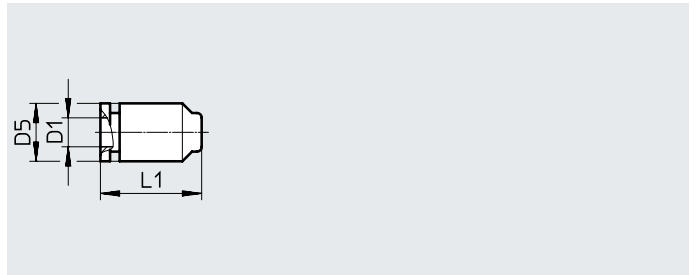

Ordering data		Dimensions [mm]		Weight/ piece	Part no.	Type	Pcs. ¹⁾
Pneumatic connection	For tubing O.D.	D5 ∅	L1				
D1				[g]			
3		6	10.5	0.5	153381	QSMC-3	10

1) Pack size

Push-in connector QSM-...H

With push-in sleeve

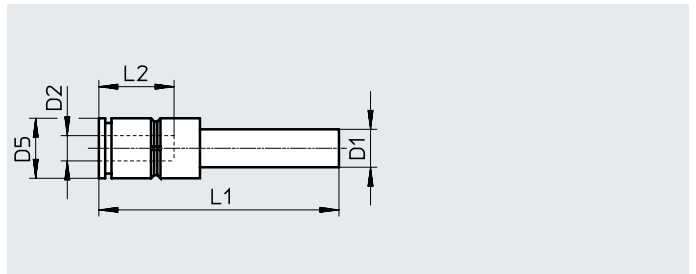

Dimensions and ordering data		Nominal width [mm]	Dimensions [mm]			Weight/ piece	Part no.	Type	Pcs. ¹⁾
Pneumatic connection	For tubing O.D.		D5 ∅	L1	L2				
Push-in sleeve	D2								
D1									
QS-3	2	1.1	6	26.3	8.4	0.6	133035	QSM-3H-2	10
QS-4	3	1.7	6	27	9.5	0.8	★ 153328	QSM-4H-3	10
							130762	QSM-4H-3-100	100
QS-6	4	2.6	9	32.6	11.6	2.4	★ 153329	QSM-6H-4	10
							130763	QSM-6H-4-100	100

1) Pack size

Blanking plug QSMC-...H

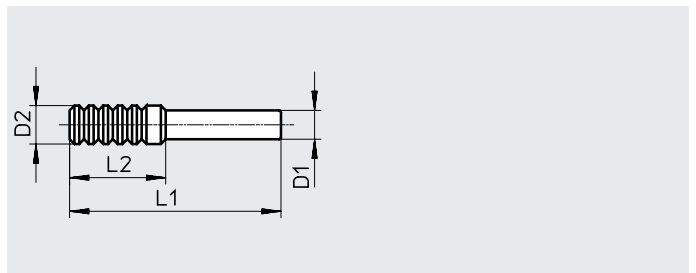

Dimensions and ordering data		Dimensions [mm]			Weight/ piece	Part no.	Type	Pcs. ¹⁾
Pneumatic connection	Push-in sleeve	D2 ∅	L1	L2				
D1					[g]			
QS-2		3	20	10.2	0.1	133036	QSMC-2H	10
QS-3		4	22	10.2	0.2	153382	QSMC-3H	10

1) Pack size

Datasheet

Push-in L-fitting QSML

Male thread with external hex, rotatable

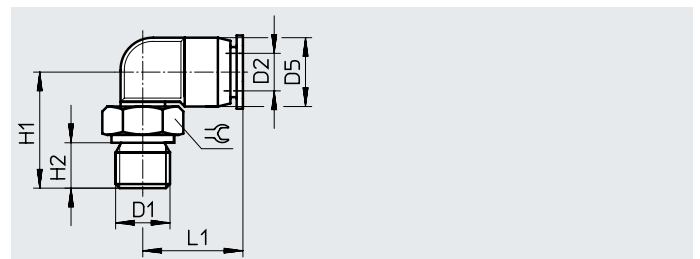
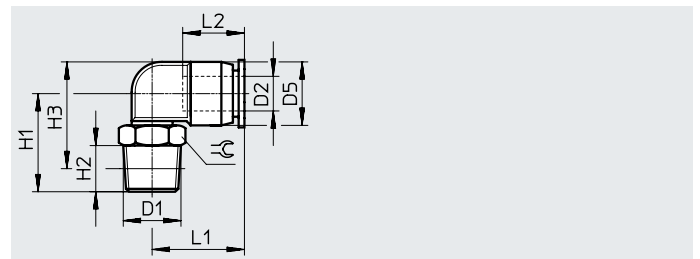
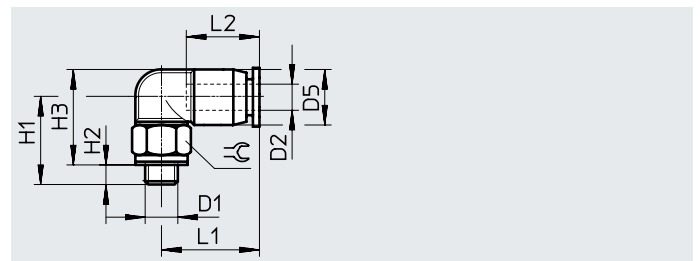

Dimensions and ordering data													
Pneumatic connection		Nominal width	Dimensions [mm]							Weight/ piece	Part no.	Type	Pcs. ¹⁾
Male thread	For tubing O.D.		D5	H1	H2	H3	L1	L2	⌀				
D1	D2	[mm]	∅							[g]			
Metric thread with sealing ring													
M3	2	0.8	6	12	2.5	12.5	10.3	8.4	5.5	1.4	133030	QSML-M3-2	10
	3		6	12	2.5	12.5	11	9.5	5.5	1.4	153330	QSML-M3-3	10
	4	1.3	8	14	2.5	15.5	15.7	11.6	8	3	★ 153332	QSML-M3-4	10
			8	14	2.5	15.5	15.7	11.6	8	3	130768	QSML-M3-3-100	100
M5	2	0.9	6	13.5	3	13.5	10.3	8.4	8	2.7	133031	QSML-M5-2	10
	3	1.5	6	13.5	3	13.5	11	9.5	8	2.8	153331	QSML-M5-3	10
			6	13.5	3	13.5	11	9.5	8	2.8	130770	QSML-M5-3-100	100
	4	1.7	8	13.5	3	14.5	15.7	11.6	8	3.4	★ 153333	QSML-M5-4	10
			8	13.5	3	14.5	15.7	11.6	8	3.4	130771	QSML-M5-4-100	100
	6	2.1	10.5	14.5	3	16.8	16.3	11.9	8	4.1	★ 153335	QSML-M5-6	10
10.5			14.5	3	16.8	16.3	11.9	8	4.1	130772	QSML-M5-6-100	100	
M7	4	2	8	17	5.5	15.5	15.7	11.6	10	5.6	★ 186352	QSML-M7-4	10
			8	17	5.5	15.5	15.7	11.6	10	5.6	130773	QSML-M7-4-100	100
	6	2.4	10.5	19	5.5	18.8	16.3	11.9	10	6.2	★ 186353	QSML-M7-6	10
			10.5	19	5.5	18.8	16.3	11.9	10	6.2	130774	QSML-M7-6-100	100
R thread													
R1/8	4	2.5	8.5	16	8	16.3	16	11.5	10	6	★ 153334	QSML-1/8-4	10
			8.5	16	8	16.3	16	11.5	10	6	130764	QSML-1/8-4-100	100
	6	3.3	11	17	8	18.5	16.5	12	10	7	★ 153336	QSML-1/8-6	10
11			17	8	18.5	16.5	12	10	7	130765	QSML-1/8-6-100	100	
G thread with sealing ring													
G1/8	4	2.5	8	16.5	5.1	-	15.7	-	13	9	★ 186268	QSML-G1/8-4	10
			8	16.5	5.1	-	15.7	-	13	9	132897	QSML-G1/8-4-100	100
	6	3.3	10.5	17.5	5.1	-	16.3	-	13	9.7	★ 186269	QSML-G1/8-6	10

1) Pack size

Datasheet

Push-in L-fitting, long QSMLL

Male thread with external hex, rotatable



M thread

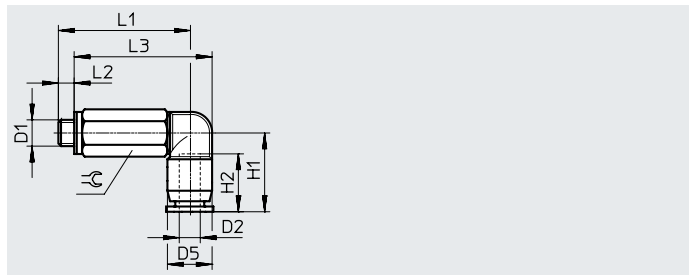

R thread

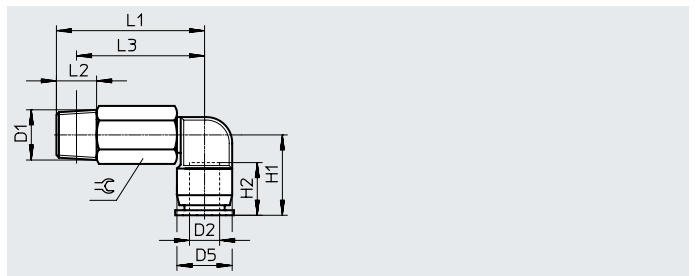

G thread

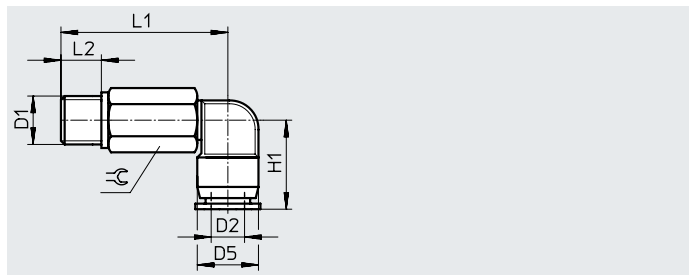

Dimensions and ordering data

Pneumatic connection		Nominal width	Dimensions [mm]							Weight/ piece	Part no.	Type	Pcs. ¹⁾
Male thread	For tubing O.D.		D5	H1	H2	L1	L2	L3	⌀				
D1	D2	[mm]	∅							[g]			
Metric thread with sealing ring													
M3	2	0.8	6	10.3	8.4	19	2.5	19.5	5.5	2.7	133032	QSMLL-M3-2	10
	3	0.9	6	11	9.5	19	2.5	19.5	5.5	2.8	153337	QSMLL-M3-3	10
											133011	QSMLL-M3-3-100	100
4	1.1	8	15.7	11.6	23	2.5	24.5	8	6.8	153338	QSMLL-M3-4	10	
M5	2	0.9	6	10.3	8.4	25	3	25	8	7.6	133033	QSMLL-M5-2	10
	3	1.5	6	11	9.5	25	3	25	8	7.7	130838	QSMLL-M5-3	10
											133012	QSMLL-M5-3-100	100
	4	2	8	15.7	11.6	25	3	26	8	8.3	153339	QSMLL-M5-4	10
	6	2	10.5	16.3	11.9	26	3	28.3	8	9	133013	QSMLL-M5-4-100	100
153341											QSMLL-M5-6	10	
M7	4	2	8	15.7	11.6	29.5	5.5	28	10	14	186354	QSMLL-M7-4	10
	6	2.4	10.5	16.3	11.9	31.5	5.5	31.3	10	14	133014	QSMLL-M7-4-100	100
											186355	QSMLL-M7-6	10
R thread													
R1/8	4	2.3	8.5	15.5	11.5	28.5	8	22	10	13	153340	QSMLL-1/8-4	10
	6	3.1	11	16.5	12	29.5	8	25.5	10	14	153342	QSMLL-1/8-6	10
G thread with sealing ring													
G1/8	4	2.3	8	15.7	-	29	5.1	-	13	23	186270	QSMLL-G1/8-4	10
	6	3.1	10.5	16.3	-	30	5.1	-	13	23	186271	QSMLL-G1/8-6	10

1) Pack size

Datasheet

Push-in L-fitting QSMLV-...-I

Male thread with internal hex, rotatable

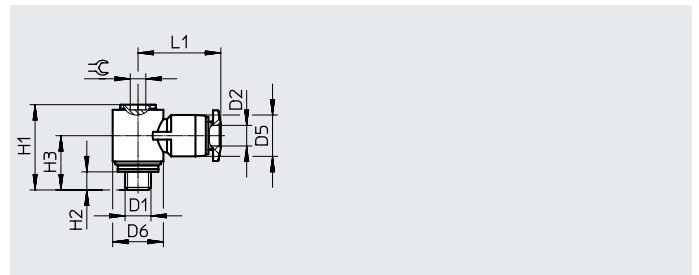

Dimensions and ordering data													
Pneumatic connection		Nominal width [mm]	Dimensions [mm]							Weight/ piece [g]	Part no.	Type	Pcs. ¹⁾
Male thread	For tubing O.D.		D5 ø	D6 ø	H1	H2	H3	L1	⌀				
D1	D2	[mm]											
Metric thread with sealing ring													
M5	3	1.7	8	9.8	16.5	3.5	10.5	16	3	5.1	130830	QSMLV-M5-3-I	10
	4	1.8	8	9.8	16.5	3.5	10.5	16	3	5	130831	QSMLV-M5-4-I	10
M7	4	1.9	8	9.8	18.5	5.5	13.2	16	3	7.4	130832	QSMLV-M7-4-I	10
	6	1.8	10.5	9.8	18.5	5.5	12.5	17.8	3	6.2	130833	QSMLV-M7-6-I	10

1) Pack size

Push-in L-fitting, long QSMLLV-...-I

Male thread with internal hex, rotatable

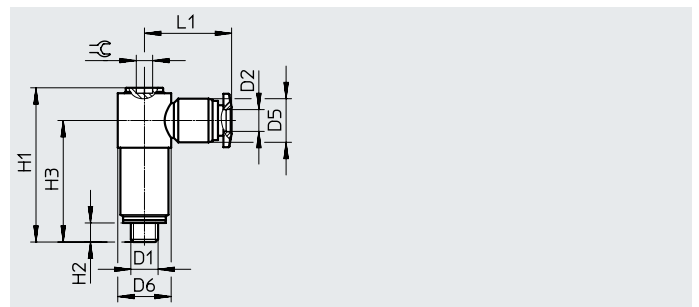

Dimensions and ordering data													
Pneumatic connection		Nominal width [mm]	Dimensions [mm]							Weight/ piece [g]	Part no.	Type	Pcs. ¹⁾
Male thread	For tubing O.D.		D5 ø	D6 ø	H1	H2	H3	L1	⌀				
D1	D2	[mm]											
Metric thread with sealing ring													
M5	3	1.6	8	9.8	28.3	3.5	23	16	3	13	130834	QSMLLV-M5-3-I	10
	4	1.8	8	9.8	28.3	3.5	23	16	3	13	130835	QSMLLV-M5-4-I	10
M7	4	1.9	8	9.8	30.3	5.5	25	16	3	14	130836	QSMLLV-M7-4-I	10
	6	1.9	10.5	9.8	30.3	5.5	24.3	17.8	3	12.4	130837	QSMLLV-M7-6-I	10

1) Pack size

Datasheet

Push-in L-connector QSML

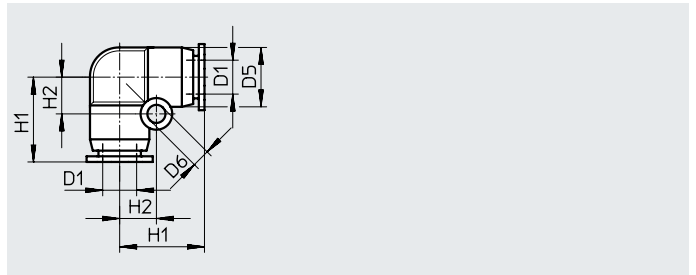

Pneumatic connection		Nominal width	Dimensions [mm]			Weight/ piece	Part no.	Type	Pcs. ¹⁾	
For tubing O.D.	D1		D5 ∅	D6 ∅	H1					H2
	3	1.7	6	3.2	11	4.5	1.5	153343	QSML-3	10
	4	2.5	8	3.2	13.5	5.5	2	★ 153344	QSML-4	10
								130766	QSML-4-100	100
	6	3.4	10.5	3.2	15.5	6.5	4	★ 153345	QSML-6	10
								130767	QSML-6-100	100

1) Pack size

Push-in L-connector QSML...H

With push-in sleeve

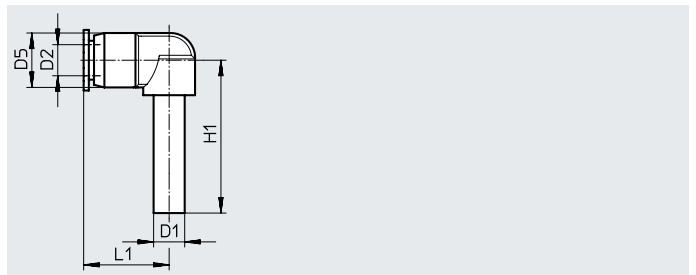

Pneumatic connection		Nominal width	Dimensions [mm]			Weight/ piece	Part no.	Type	Pcs. ¹⁾
Push-in sleeve	For tubing O.D.		D5 ∅	H1	L1				
D1	D2	[mm]				[g]			
QS-3	3	1.2	9	24	14.7	1.7	153346	QSML-3H	10
QS-4	4	1.9	9	25	14.7	1.7	★ 153347	QSML-4H	10
QS-6	6	3.2	10.5	26.5	17.3	2.4	★ 153348	QSML-6H	10
Reducing									
QS-4	3	1.7	9	25	14.7	1.7	★ 153349	QSML-4H-3	10
QS-6	4	1.9	9	26	14.7	1.9	★ 153350	QSML-6H-4	10

1) Pack size

Datasheet

Push-in T-fitting QSMT

Male thread with external hex, rotatable

No. of supply lines: 1

No. of outlets: 2



M thread

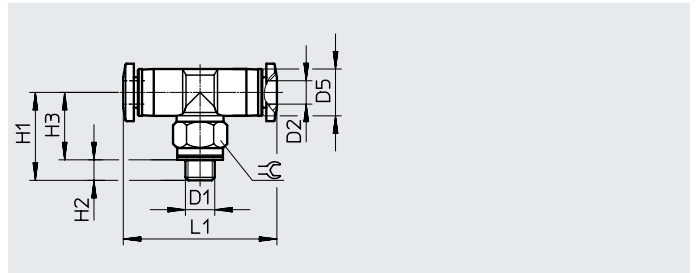

R thread

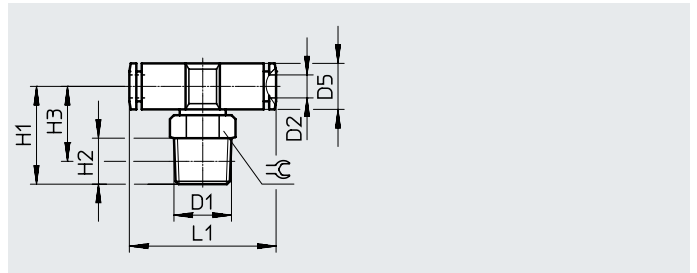

G thread

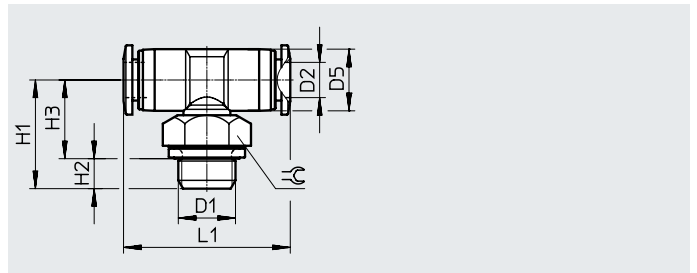

Dimensions and ordering data

Pneumatic connection		Nominal width [mm]	Dimensions [mm]							Weight/ piece [g]	Part no.	Type	Pcs. ¹⁾
Male thread	For tubing O.D.		D5 ∅	H1	H2	H3	L1	⌀					
D1	D2												
Metric thread with sealing ring													
M3	3	0.9	6	12.8	3.3	9.5	22	5.5	2	153351	QSMT-M3-3	10	
	4	1.3	8	15.8	3.3	12.5	26.2	8	4	153353	QSMT-M3-4	10	
M5	3	1.6	6	14	3.5	10.5	22	8	3.3	153352	QSMT-M5-3	10	
	4	2.2	8	15	3.5	11.5	26.2	8	4.4	153354	QSMT-M5-4	10	
										130784	QSMT-M5-4-100	100	
	6	2.1	10.5	16	3.5	12.5	28.4	8	5.6	153356	QSMT-M5-6	10	
										130785	QSMT-M5-6-100	100	
R thread													
R1/8	4	2.4	8.5	17	8	13	27	10	7	153355	QSMT-1/8-4	10	
	6	3.3	11	18	8	14	30	10	8	153357	QSMT-1/8-6	10	
G thread with sealing ring													
G1/8	4	2.4	8	17.5	5.1	12.4	26.2	13	10	186272	QSMT-G1/8-4	10	
	6	3.3	10.5	18.5	5.1	13.4	28.4	13	12	186273	QSMT-G1/8-6	10	

1) Pack size

Datasheet

Push-in T-fitting QSMTL

Male thread with external hex, rotatable

No. of supply lines: 1

No. of outlets: 2



M thread

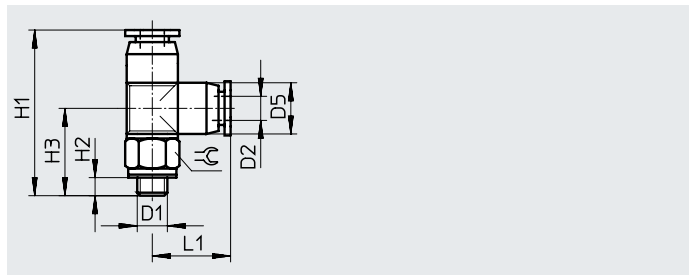

R thread

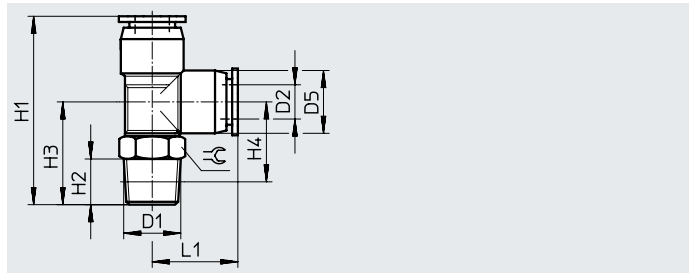

G thread

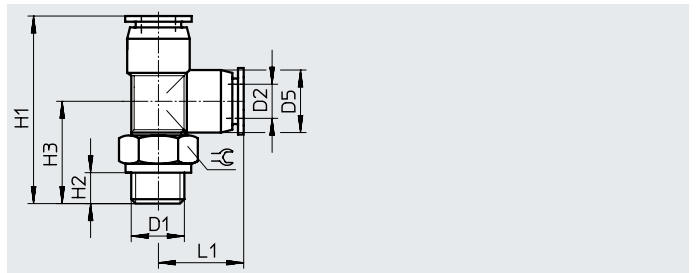

Dimensions and ordering data

Pneumatic connection		Nominal width	Dimensions [mm]							Weight/ piece	Part no.	Type	Pcs. ¹⁾
Male thread	For tubing O.D.		D5 ∅	H1	H2	H3	H4	L1	⊕				
D1	D2	[mm]								[g]			
Metric thread with sealing ring													
M3	3	0.9	6	23.8	3.3	12.8	-	11	5.5	2	153358	QSMTL-M3-3	10
	4	1.1	8	29.5	3.3	15.8	-	13.7	8	4	153360	QSMTL-M3-4	10
M5	3	1.7	6	25	3.5	14	-	11	8	3.3	153359	QSMTL-M5-3	10
	4	1.6	8	28.7	3.5	15	-	13.7	8	4.4	153361	QSMTL-M5-4	10
	6	1.7	10.5	31.3	3.5	16	-	15.3	8	5.7	153363	QSMTL-M5-6	10
R thread													
R1/8	4	2.4	8.5	30	8	17	13	13	10	7	153362	QSMTL-1/8-4	10
	6	3.3	10.5	33	8	18	14	15	10	8.5	153364	QSMTL-1/8-6	10
G thread with sealing ring													
G1/8	4	2.4	8	31.2	5.1	17.5	-	13.7	13	10	186274	QSMTL-G1/8-4	10
	6	3.3	10.5	33.8	5.1	18.5	-	15.3	13	12	186275	QSMTL-G1/8-6	10

1) Pack size

Datasheet

Push-in T-connector QSMT

No. of supply lines: 1

No. of outlets: 2

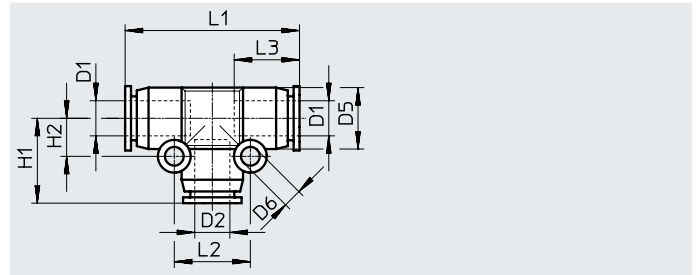

Dimensions and ordering data													
Pneumatic connection		Nominal width [mm]	Dimensions [mm]							Weight/ piece [g]	Part no.	Type	Pcs. ¹⁾
For tubing O.D. D1	For tubing O.D. D2		D5 ∅	D6 ∅	H1	H2	L1	L2	L3				
2	2	0.9	6	3.2	10.3	4.5	20.5	9	8.4	1.6	133034	QSMT-2	10
3	3	1.6	6	3.2	11	4.5	22	9	9.5	1.7	153365	QSMT-3	10
4	4	2.4	8	3.2	13.7	5.6	27.3	11.2	11.6	3.3	★ 153366	QSMT-4	10
											130782	QSMT-4-100	100
6	6	3.4	10.5	3.2	15.3	6.6	30.5	13.2	11.9	5.3	★ 153367	QSMT-6	10
											130783	QSMT-6-100	100
Reducing													
4	3	1.7	8	3.2	13	5.5	27	11	11.5	3.5	★ 153368	QSMT-4-3	10
6	4	2.6	10.5	3.2	15	6.5	30	13	12	4	★ 153369	QSMT-6-4	10

1) Pack size

Datasheet

Push-in X-connector QSMX

No. of supply lines: 1
No. of outlets: 3

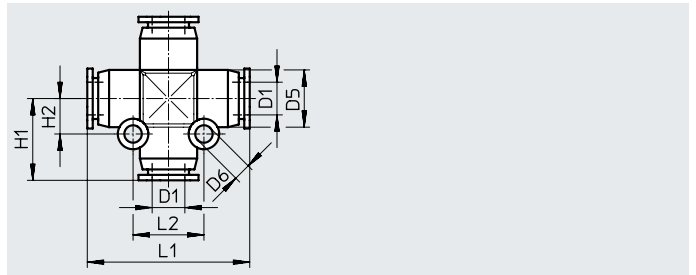

Dimensions and ordering data												
Pneumatic connection		Nominal width	Dimensions [mm]					Weight/ piece	Part no.	Type	Pcs. ¹⁾	
For tubing O.D.	D1		D5 ∅	D6 ∅	H1	H2	L1					L2
		[mm]							[g]			
3		1.7	8	3.2	13.5	5.5	27	11	4	153378	QSMX-3	10
4		2.5	8	3.2	13.5	5.5	27	11	4	153379	QSMX-4	10
6		3.3	10.5	3.2	15.5	6.5	31	13	5	153380	QSMX-6	10

1) Pack size

Push-in Y-connector QSMY

No. of supply lines: 1
No. of outlets: 2

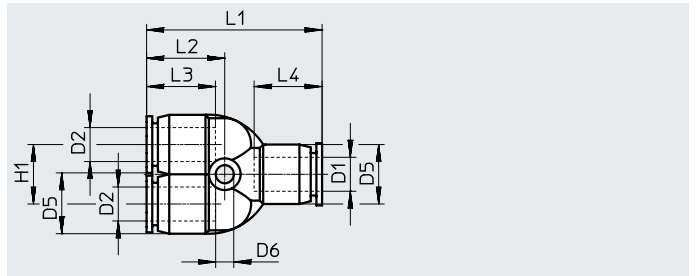

Dimensions and ordering data													
Pneumatic connection		Nominal width	Dimensions [mm]							Weight/ piece	Part no.	Type	Pcs. ¹⁾
For tubing O.D.	For tubing O.D.		D5 ∅	D6 ∅	H1	L1	L2	L3	L4				
D1	D2	[mm]								[g]			
2	2	0.9	6	3.2	6.5	19.5	11.8	8.4	8.4	1.7	133037	QSMY-2	10
3	3	1.6	8	3.2	8	28.8	13.2	11.6	11.6	3.7	153370	QSMY-3	10
4	4	1.7	8	3.2	8	28.8	13.2	11.6	11.6	3.5	★ 153371	QSMY-4	10
											130786	QSMY-4-100	100
6	6	2.9	10.5	3.2	10.5	31.6	14.3	11.9	11.9	5.5	★ 153372	QSMY-6	10
											130787	QSMY-6-100	100
Reducing													
4	3	1.6	8	3.2	8	28.8	13.2	11.6	11.6	3.6	★ 153373	QSMY-4-3	10
6	4	2.3	10.5	3.2	10.5	31.5	14.2	11.6	11.9	5.3	★ 153374	QSMY-6-4	10

1) Pack size

Accessories

Releasing tool QSO

Releasing tool for disconnecting tubing from the plug-in connection in locations that are difficult to access.



Dimensions and ordering data

For tubing O.D.

	Weight/ piece [g]	Part no.	Type
4, 6, 8, 10	13	158419	QSO

Festo - Your Partner in Automation



1 Festo Inc.
5300 Explorer Drive
Mississauga, ON L4W 5G4
Canada

Festo Customer Interaction Center
Tel: 1 877 463 3786
Fax: 1 877 393 3786
Email: customer.service.ca@festo.com

2 Festo Pneumatic
Av. Ceylán 3,
Col. Tequesquináhuac
54020 Tlalnepantla,
Estado de México

Multinational Contact Center
01 800 337 8669
ventas.mexico@festo.com

3 Festo Corporation
1377 Motor Parkway
Suite 310
Islandia, NY 11749

Festo Customer Interaction Center
1 800 993 3786
1 800 963 3786
customer.service.us@festo.com

4 Regional Service Center
7777 Columbia Road
Mason, OH 45040

Connect with us



www.festo.com/socialmedia



www.festo.com

Subject to change